

2 Hyperview Browser

2.1 How to run Hyperview, load a project file, and get help

DBDOC organises all your INFI 90 documents into a single package to give you fast, easy, read-only access to the information you need to do your job. Hyperview is the browser that navigates through this view of your system.

2.1.1 How to Run Hyperview

2.1.1.1 Starting Hyperview from a desktop shortcut

Usually Hyperview users are provided with a desktop Hyperview shortcut, allowing Hyperview to be maintained in a central location accessible to many users. To run Hyperview, double click on the shortcut. The last project file viewed will be automatically loaded.

2.1.1.2 Starting Hyperview from the Start Menu

If Hyperview is installed directly on your, machine, access it via the **Start** menu - under **Programs** look for either a **GMCL DBDOC** or **GMCL DBDOC Hyperview** folder and click on the **Run Hyperview** option.

2.1.1.3 Launching an additional Hyperview window

You can also launch a new Hyperview window by selecting the **New Window** option from the **File** menu inside of Hyperview. This will launch another copy of Hyperview viewing the same project and topic that you are currently viewing. The new copy will inherit the same command line parameters as the copy that spawned it.

2.1.1.4 Advanced: Running Hyperview from the command line

Command Line Options:

You can launch Hyperview via the command line. You may specify the name of the project file to open, as well as, optionally, a particular document within the project to display when it first opens up. You may also append additional optional arguments.

The command line takes the following form:

```
"<Installed_program_location>\hyperview.exe"  
  <dbdoc file>  
  </document_switch=document_name>  
  </additional_optional_switches>
```

In practice this will take one of three forms:

Specifying a general document to open:

```
"<Installed_program_location>\hyperview.exe"  
  <project file>  
  </doc=document_name> </type=document_type>  
  </additional_optional_switches>
```

Specifying a block whose source in the configuration will be displayed:

```
"<Installed_program_location>\hyperview.exe"
  <project file>
</block=block_specification>
</additional_optional_switches>
```

Specifying a tag whose source in the configuration will be displayed:

```
"<Installed_program_location>\hyperview.exe"
  <project file>
  </tag=tag_name>
</additional_optional_switches>
```

Command line arguments:

- **<project file>** is the location and name of the .dbdoc (previously .M14) file to open.
 - ◆ In lieu of an actual filename, you can use the asterisk (*) wildcard to open the newest project file in the location specified.
 - ◆ If no filename is present, Hyperview will open the last project file that you were viewing.

- **</doc=document_name>** is the name of the document (without suffix) to open.

-- document_switch is one of the following arguments followed by the **document_name** (do not include the file extension in the name):

Argument	Explanation	Example
/doc	Specify a document to open. The optional <i>/type</i> switch specifies the document type to be opened. The first document (of the specified type) that has a name with a leading substring that matches the string specified in <i>/doc</i> will be opened. If <i>/type</i> is not specified, then the first matching document of any type will be opened. Strictly speaking, it is only necessary to specify <i>/type</i> in cases of document name ambiguity. A wide variety of types, such as graphic , cad , dxg etc. can be specified. See Launching Hyperview from the command line in the Hyperview Reference Guide for complete information.	<i>/doc="G1WATER" /type=graphic</i>
/tag	Tag Name	<i>/tag="AMD-108"</i> (Note: This will bring up the tag index in the Table of Contents panel and the CAD or CLD source, if it exists, in the content pane.)
/block	Database record	<i>/block="Module 1,1,1 Block 1"</i> (Note: The index pane should show everywhere this block is referenced. The content pane will display the CAD or CLD sheet source of the specified block.)

2.1.2 How to load a project file

2.1.2.1 Opening a specific project file

To open a different project file follow the following steps:

1. Go to the **File** menu and click **Open**.
2. A standard Windows browse dialog box will open.
3. Navigate to the location of the file.
4. Click **Open**.

2.1.2.2 Opening a recent project file

You are also able to navigate to the **File** menu and click the **Recent Project Files** selection to pick a project file from the last twelve files that were viewed.

The name of the last viewed project file is now stored in the registry. When Hyperview is run from the **Start** button, it will be loaded with the last project viewed. Hyperview also stores the names of the last twelve viewed project files and lists them in the **Recent Project Files** option under the **File** menu. This allows for quick navigation between recently viewed project files.

2.1.2.3 Advanced: Opening the most recently built project file

Shortcuts to Hyperview can specify a wildcard project file specification (i.e., containing *). Hyperview opens the newest file that matches the wildcard specification. The advantage of using wildcards like this is that you do not have to rework your shortcuts with each new build and you can use the automatic renaming technique in BuildPlus to archive your built project files.

2.1.2.4 Advanced: Associating project files with Hyperview in Windows

To make Hyperview open when you double-click a project file, you can associate the project file type (.dbdoc, previously .M14) with Hyperview in Windows by following the steps below:

1. Go to the **Start** menu, click on **Control Panel**, locate the **Folder Options** icon and double-click on it.
2. Once the **Folder Options** window is open click on the **File Types** tab.
3. Click the **New** button below the Registered File Types.
4. In the **File Extension** box enter **dbdoc** as the File Type.
5. Once it is added click the **Change** button below the **File Types** box.
6. Choose the select the program to open the file from a list selection.
7. Browse to `C:\Program Files\GMCL\DBDOC\Programs` and select `hyperview.exe` as the program to open the file.

2.1.3 Help and Documentation

2.1.3.1 How to access the built-in help documentation

The **Contents**, **Index**, or **Search for Help** on the Hyperview **Help** menu will launch the DBDOC compiled help. Selecting any one of these will launch the DBDOC compiled help, opened on the appropriately named tab. The help file contains information on how to use BuildPlus, Hyperview, and CIUMon, appendices on other programs and components, and our FAQ (Frequently Asked Questions) with useful information about builds, set-ups or other problems you may encounter.

2.1.3.2 Help and tutorials on the GMCL website

Go to GMCL website on the Hyperview **Help** menu will launch Internet Explorer and take you to the Help page on the GMCL website. There you can access all the same information as in the built-in help, as well as interactive tutorials, user guides, and other documentation.

2.1.3.3 How to use the What's This feature

What's This? on the Hyperview **Help** menu can be used to show a brief description of any toolbar button or menu option.

2.1.3.4 Finding the version of Hyperlink that built the current project file

Current Project File Revision on the Hyperview **Help** menu will bring up a dialog box that contains information about the current project being viewed - the version of hyperlink that was used to build it and when it was last built.

2.1.3.5 Figuring out what version of Hyperview is running

About on the Hyperview **Help** menu contains the following information about the version of Hyperview currently running:

- Hyperview version
- DBDOC Kit Version
- Winsock / No Winsock
- Last compiled date (of Hyperview)
- Hyperview build revision

2.1.3.6 Other ways of getting help

You may also click on various items to get more information. If it is a dialog box that you need more information on, use the associated contextual help. Click the **Help** button in the upper right hand corner of the dialog box and then click on the desired item to see a description.

2.2 Guide to basic navigation in Hyperview

2.2.1 Panes in Hyperview

The Hyperview browser shows two panes, or display areas. The pane on the left (or top) is called the index, or **Table of Contents** pane. It is used for indexes and summaries of information. The pane on the right (or bottom) is called the content, or topic pane. It is generally used to display documents and graphics, although certain types of indexes and reports can also be displayed there.

2.2.1.1 Specifying the pane orientation

You can set Hyperview up so that the index pane can be located at the left or top while the content pane will be located on the right or bottom respectively.

To change the orientation of Hyperview, click one of the following buttons in the toolbar:



They will produce the following results:

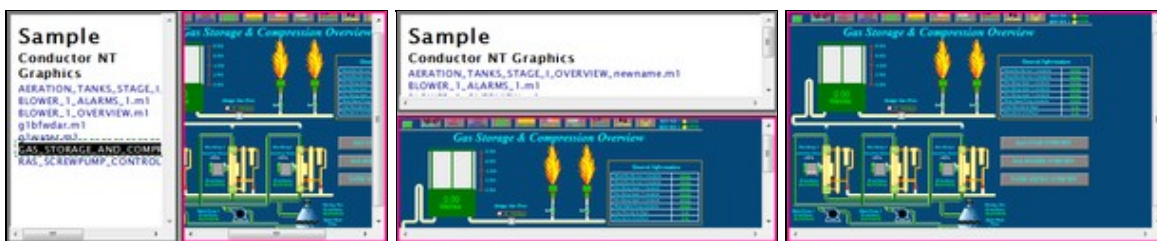

You can use the following menu options or commands to change the view from a menu or shortcut key:

- Select **Change Pane Orientation** from the **View** menu.
- Select the **View** from the drop down list on the **View** tab in **Options**.
- Position the cursor on the border until it becomes the split cursor and drag the cursor to the view that you would like.
- Press **J** on the keyboard or select **Split Adjust** from the **View** menu to get the split cursor.
- Adjust the view to full screen by pressing **F** on the keyboard, selecting **Full Screen** from the **View** menu or double-clicking the border between the two panels.
- Drag the borders between the index and content panes until the index pane disappears.

Your viewing preferences are stored so that each time Hyperview is launched it will open to your last used settings.

The settings it saves are:

- Size of the Hyperview window
- Position of the window
- Size of index and content panes
- Classic or Treeview Table of Contents

2.2.2 Index pane

When you first start Hyperview, the index pane provides a view of the **Table of Contents**, a summary of all the content contained in your project file.

2.2.2.1 Displaying the Table of Contents

To display the general Table of Contents:

- Click the Table of Contents toolbar button 
- **OR** press **T**
- **OR** on the **Go** menu, click **Table of Contents**.

2.2.2.2 Switching between Classic and Treeview Table of Contents

There are two ways of displaying the **Table of Contents**. The first view is **Classic View**. It provides a detailed view of your build content, but you generally have to scroll down a long way to get to what you want. **Treewiew** is a compressed, collapsible/expandable, easy-to-use overview, similar to Windows Explorer.

To switch between views for the Table of Contents:

- Press **Ctrl+T**.
- **OR** on the **View** menu, click **Table of Contents as Tree**.

To collapse the open nodes in the tree view table of contents:

- Press **T**.
- **OR** click the **Table of contents** toolbar button .

The following are examples of the the **Classic** (left) and **Treewiew** (right) table of contents.

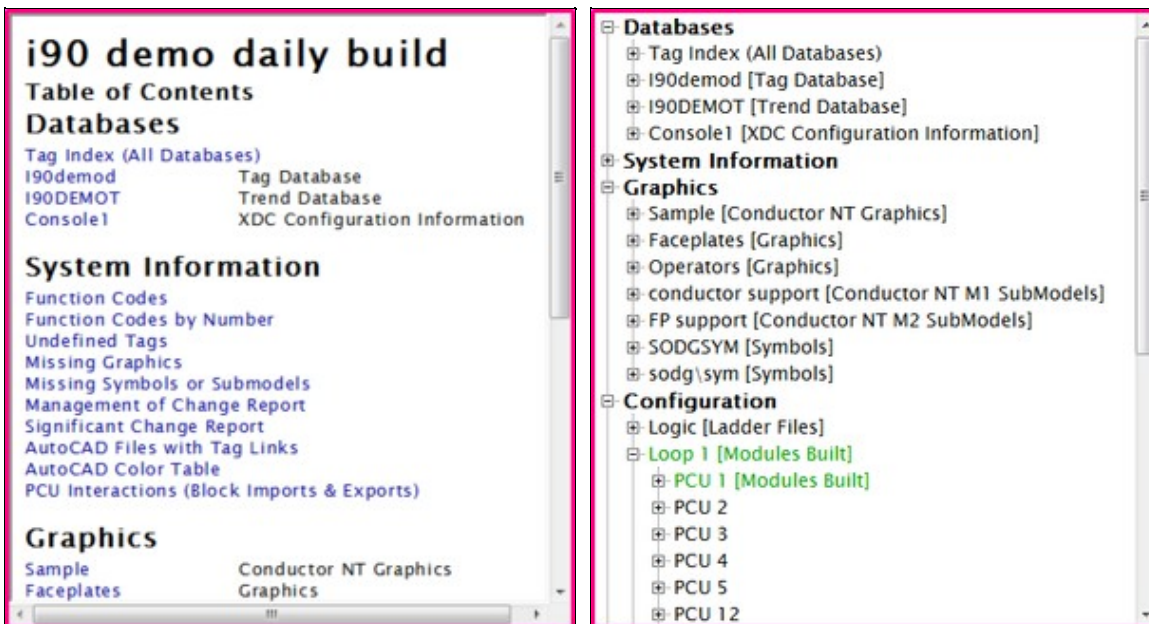



2.2.2.3 Clicking on hotspots in the index pane

Some of the items in the index pane are hotspots, or hyperlinks (indicated in blue). In general, clicking on a name-of-document hotspot in the **Table of Contents** causes that document to be displayed in the content pane below or on the right. The exception is when the item in the index pane is the name of another index. Clicking on a name-of-index hotspot in the **Table of Contents** will cause the new index to be loaded into the index pane. Hyperview indexes will be discussed in more detail later.

Rarely, the hotspot in the index pane is a link to an external document, i.e. one that is not built into the project file. When this is the case, a "proxy" document (with a title and link to the "real" document) is displayed in the content pane. Clicking on the link in the proxy document causes the external document (e.g. a PDF file with function code documentation) to be opened in your default PDF viewer application.

2.2.2.4 Index navigation

- **Go to Next/Previous Topic** 
 - ◆ Go to the next/previous topic in the browse sequence.
 - ◆ This is dependent on which side the focus is on.
 - ◆ Use **B** and **Shift-B** on the keyboard or select from the **Go** menu.
- **Go to Next/Previous Index link** 
 - ◆ In an index, go to the next/previous hyperlink in sequence.
 - ◆ Use **L** and **Shift-L** on the keyboard or select from the **Go** menu.

2.2.3 Content pane

The content pane is where documents such as Operator Graphics, CAD/CLD diagrams, reports, text documents, Tag and Trend Database entries, and other resources are displayed. These documents generally contain hotspots, or hyperlinks. Clicking on different sorts of hotspots will have different effects in the Hyperview browser, depending on the type of hotspot. Some link directly to other documents, while others represent blocks and allow signal tracing.

2.2.3.1 Displaying hotspots

There are typically many hotspots on a document in the content pane. When you move the mouse over a hotspot, the cursor will change to a "pointing finger" shape. You can also highlight all the hotspots on a page by pressing **Ctrl+Tab** or selecting **Hotspots** on the **Highlight** menu. You can also hover over a hotspot to see a brief description in a tooltip.

2.2.3.2 Clicking on a hotspot to see all the uses of a value

Many hotspots represent a block or tag value. Clicking on a block or tag hotspot will cause all the places the block or tag is used to be displayed in the index pane.

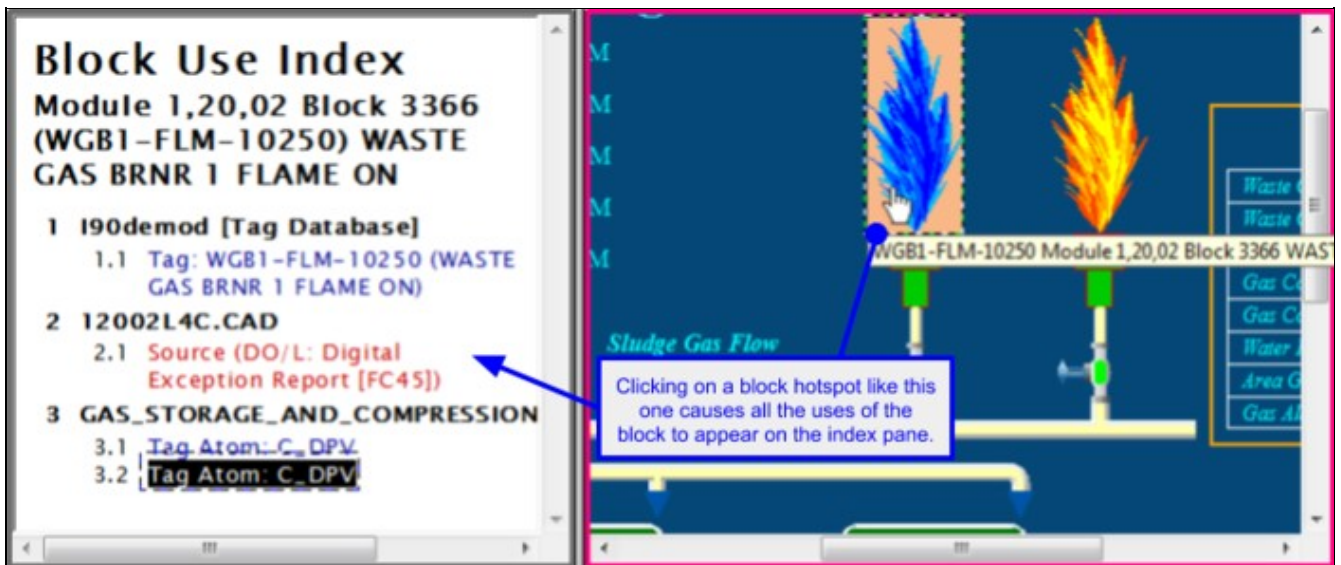



Clicking on the value on the right brought up all the places in the system that that block is used, both as a tag name and as a block. In this example, the selected block appears in the tag definition, on two CAD/CLD configuration sheets, in text documentation, in this graphic, and on an AutoCAD drawing. All this information is right in front of you.

2.2.3.3 Double clicking on a hotspot to go to the source of a value

Most hotspots are associated with blocks in the configuration. Double click on any block-hotspot to display the block source in the configuration.

2.2.4 Focus for the active window

Focus is shown by the color border on the index or content pane and shows which side of the browser you are working in. It affects printing and the **Next Topic**  and **Previous Topic**  buttons. To set focus in a particular pane, click the mouse on some white space (where the cursor remains an arrow) in that pane.

2.2.5 Setting a "Home Page" for your index and content panes

You can specify home pages for your index and content panes. If none are specified, then the **Home** button will return you to the classic opening view.

2.2.5.1 Setting your "Home Page" to the current document

You can easily set your homepage to a topic that is currently displayed in the Hyperview browser.

- Right-click on a topic. In the popup menu that appears, you can easily set the home button to call up the desired page using **Make This Topic My Index Pane Home Page** (if the index pane has focus) or **Make This Topic My Content Pane Home Page** (if the content pane has focus).

Your home pages are saved in your user logon (in the same location as your annotation, bookmark and history files). They will stay intact when the DBDOC files are updated and the project rebuilt. Typical content pane home pages are overview graphics that get you anywhere in the plant in one click.

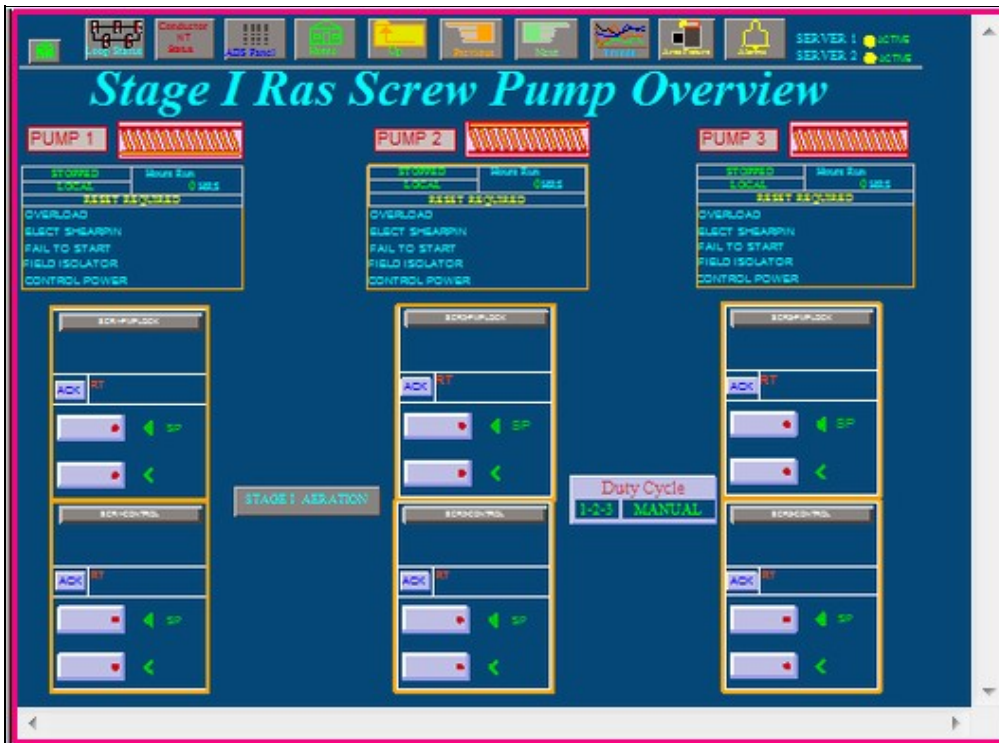

2.2.6 Scrolling

Note: As of DBDOC 11.3, Hyperview supports two different scroll and zoom modes. The original mode (can be selected as **Legacy scroll & zoom mode** in the View tab of the Options Dialog) supports scrolling via the scrollbar and scroll wheel. The new mode, now the default, allows scrolling by dragging, and the scroll wheel zooms. Holding down the **Ctrl** key will temporarily enable the non-selected mode.

2.2.6.1 Default mode scrolling

By default, graphical documents can be scrolled with the scrollbar, or by dragging with the mouse. The scroll wheel now zooms graphical documents. Text documents can be scrolled with the scrollbar or with the scroll wheel.

2.2.6.2 Legacy scroll & zoom mode scrolling

When Hyperview is in **Legacy scroll & zoom mode**, all documents can be scrolled with the scrollbar or scroll wheel. Dragging does not scroll, but rather zooms on graphical documents.

Note that the unselected mode can be enabled transiently by holding down the **Ctrl** key. So, you could access drag-panning even in **Legacy scroll & zoom mode** by pressing **Ctrl**, and then dragging with the mouse.

2.2.7 Zooming

Note: As of DBDOC 11.3, Hyperview supports two different scroll and zoom modes. The original mode (can be selected as **Legacy scroll & zoom mode** in the View tab of the Options Dialog) supports "rubber-band" zooming on graphical documents. The new mode, now the default, enables scroll wheel zooming. Holding down the **Ctrl** key will temporarily enable the non-selected mode.

2.2.7.1 Default mode zooming with the mouse



Place the mouse above the spot you wish to zoom in or out on, and scroll up with the scroll wheel to zoom in, or scroll down to zoom out.

2.2.7.2 Legacy scroll & zoom mode zooming with the mouse

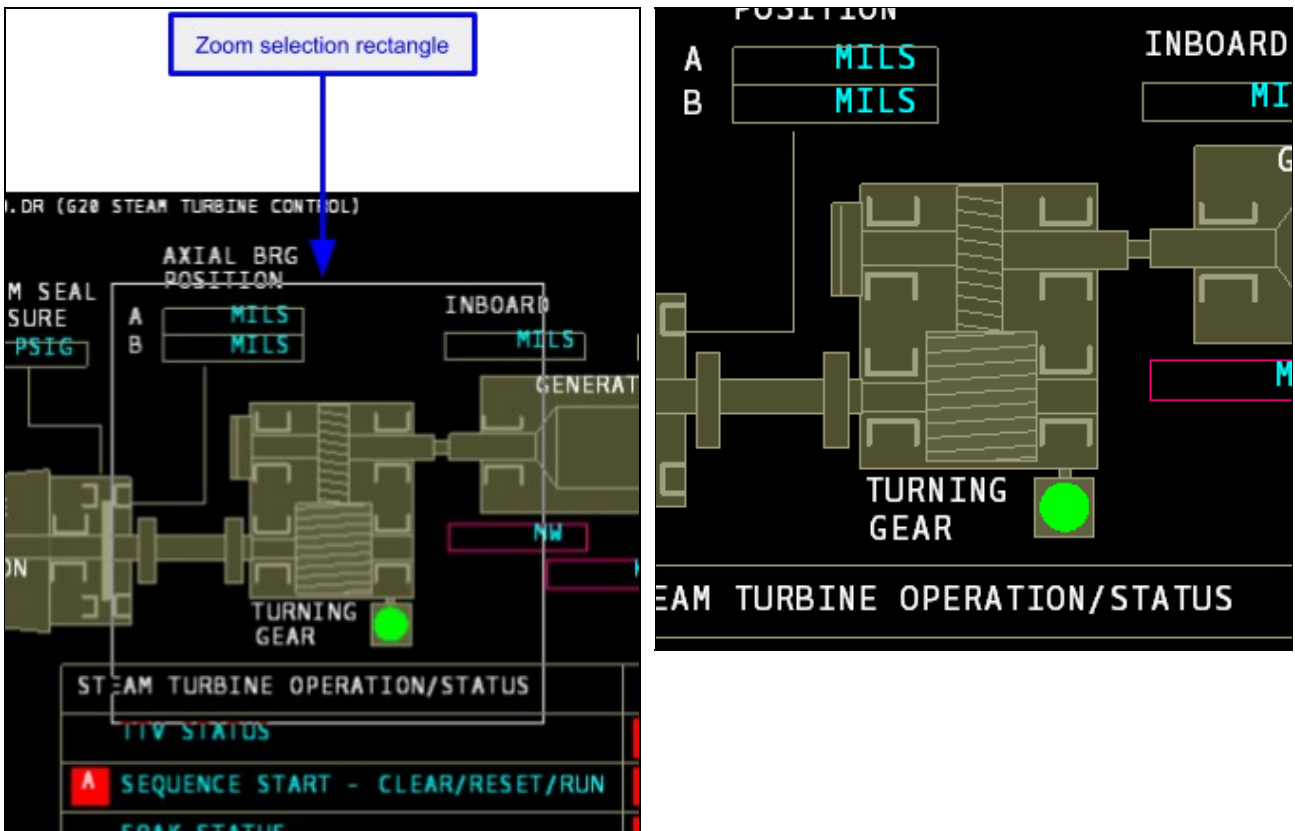
Click and drag a rectangle in the content pane around the area that you want enlarged. When you have finished dragging, Hyperview will centre your selection in the pane, magnified to fit.



2.2.7.3 Zooming with toolbar buttons or the keyboard

- To zoom in to double the zoom level, click the **Zoom In** button  or press +
- To zoom out to half the zoom level, click the **Zoom Out** button  or press -
- To toggle between full view and the previous zoom level, click the **Zoom Toggle** button  or press **Z**
- Zoom functions are also available through the **View** menu.

2.2.7.4 Manually setting the magnification factor

You can manually set the magnification factor for any graphical topic (graphic, CAD/CLD sheet and AutoCAD drawing).

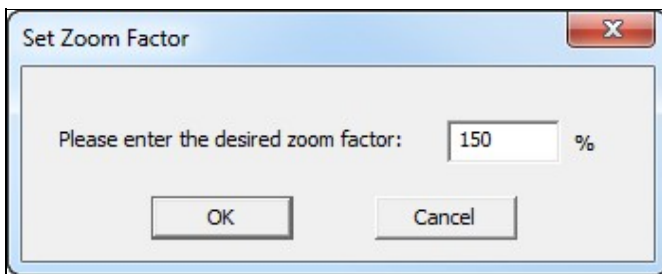

- Right click on the drawing and select **Set Zoom Factor** from the popup menu.
- Enter the zoom factor you wish to apply to the topic.



2.2.8 Using browser history to return to previously viewed documents

Hyperview history is similar to that of other browsers like Internet Explorer.

Going backward and forward in the browser history:

- Click the **Go Back** button  or **Go Forward** button  to go to

the previous or next item.

- Activate the drop down menu for the forward and backward lists by clicking on the arrow to the right of the button and selecting the desired item.
- The last document viewed is retained across builds. This is stored in `<project_name>.hst` in the same location as your annotation, bookmark and home page files.

2.2.9 Using bookmarks for quick access to pages of interest

Flag special pages for quick access! These can be added to any document.

To bookmark a topic:

- Click on the **Add Bookmark**  button on the toolbar.
- **OR** Choose **Define** under the **Bookmark** menu

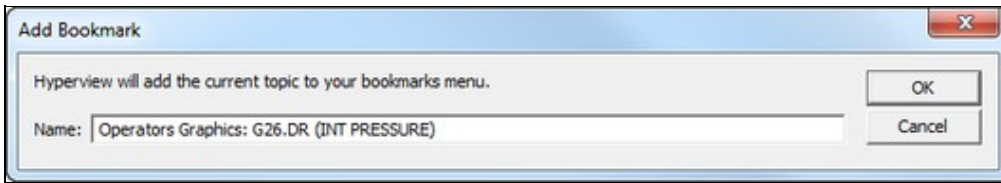

- **OR** Press **Ctrl+D** to add the document directly. This option will add the document to the bookmark list without bringing up the **Add Bookmark** dialog where you can edit how the text will read in the list.

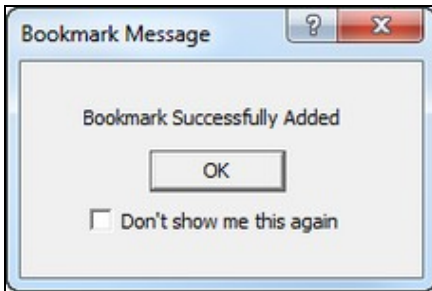

Multiple bookmarks with the same name are not allowed. If you try to define a bookmark with a name that already exists, Hyperview will bring up a message box to warn you of the duplication. It will give you the option of editing the current bookmark name or canceling the operation.

Using and managing bookmarks:

Bookmarks will be appended to the **Bookmark** menu as a new menu item. Select the desired bookmark from the menu and jump to the corresponding topic. Edit or delete bookmarks by selecting the **Manage** option from the **Bookmark** menu which will open the following window:

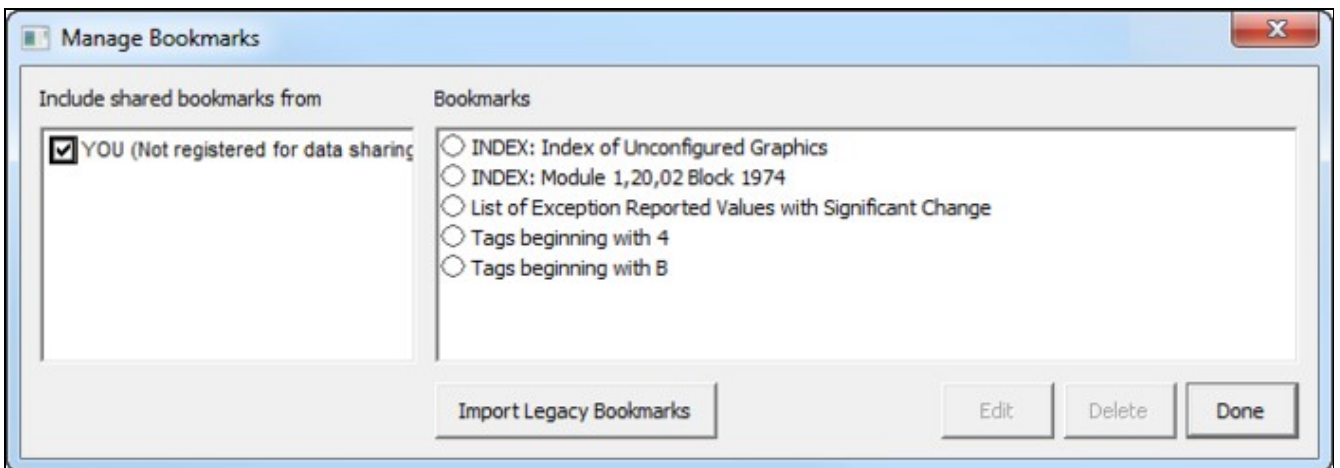

Bookmarks not only remember the document you were on, but the zoom factor, scroll position and hotspot highlighting as well.

Sharing your bookmarks:

You can automatically share your bookmarks with other users, and have access to their bookmarks. To do this, configure User Data Sharing in the **Sharing** tab of the **Options** dialog. Once you have registered in a Shared Data Folder, you will have access to the bookmarks created by other users registered in the same Shared Data Folder. See **Sharing Data with Other Hyperview Users** for more information about setting this up.

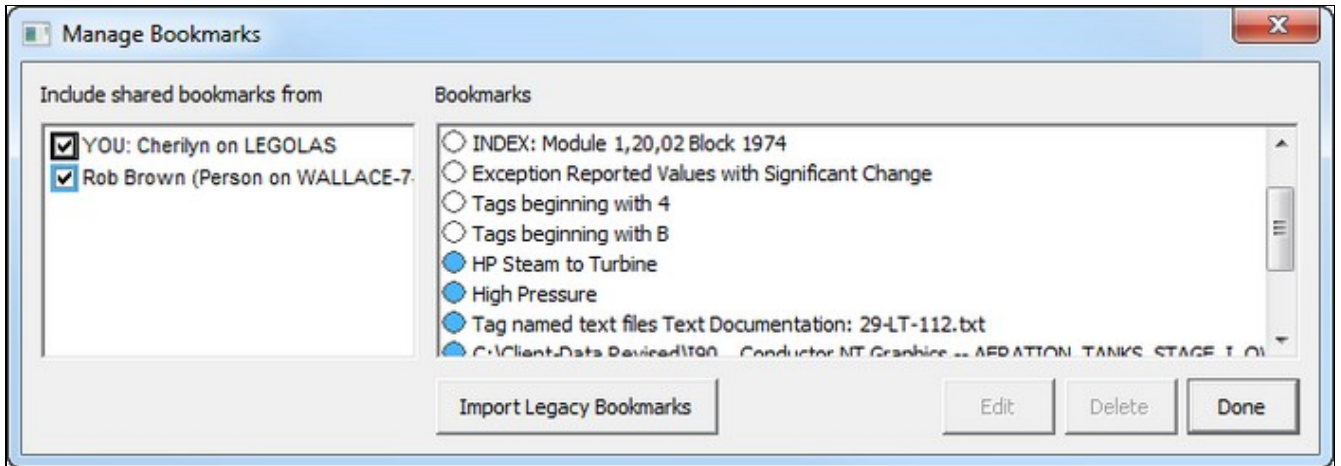

Bookmarks not only remember the document you were on, but the zoom factor, scroll position and hotspot highlighting as well.

2.3 Techniques for tracing inputs and outputs throughout your system

2.3.1 Overview of signal tracing in Hyperview

There are two basic ways to trace signals in Hyperview:

1. You can click on hotspots in the content pane in order to display uses of the hotspot value in the index pane. Clicking on a use in the index pane causes the document with the use in it to be displayed in the content pane. This method of signal tracing requires that the index pane be visible, so it cannot be used when the browser is in "full screen" mode. On the other hand, the list of uses of a value is displayed in the index pane until you change it, and this list can be printed and perused at leisure.
2. You can double-click or use the context menu on hotspots to jump directly to the source of a value (bypassing the index pane), or to display a list of uses in the context menu that you can select from. This method of signal tracing can be used even when the browser is in "full screen" mode with the index pane not visible. The downside is that the index of uses of a value is only temporarily visible.

2.3.2 Tracing signals using hotspots and the index pane

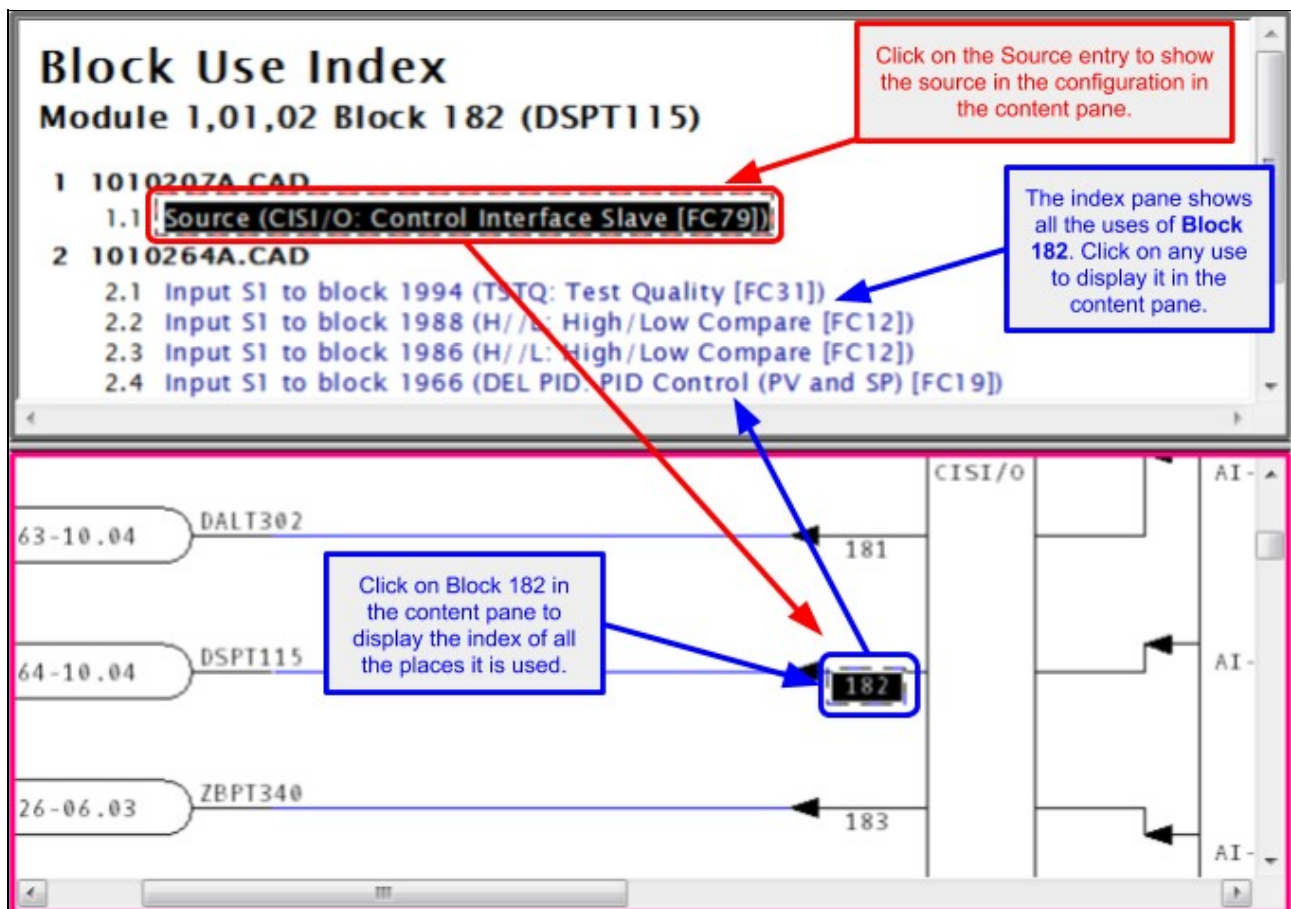



2.3.2.1 Tracing back to the source of a value

To trace a signal, use the follow steps and refer to the image below:

1. Click on an item of interest in the right side content pane
2. Click on item labeled source, in red in the index pane, if it exists, then click on an input to the block newly highlighted in the Content pane
3. Repeat until you have traced back far enough.

Viewing live data on the fly:

- At any point, you can turn on live monitoring to check what the values are.
- If you use **Slow Mode** , monitoring will stay on from document to document, and values will be fetched whenever you change documents.
- In **Continuous Mode**  monitoring, monitoring is automatically turned off when you go to another document.

2.3.2.2 Finding and displaying the uses of a value

Simply click on any tag or block in either the content pane or the index pane. Its source and uses will be displayed in the index pane. The source is always displayed in red. By default all uses are displayed in blue.

2.3.3 Tracing signals using Go To Use, Go To Source, and double-clicking on hotspots

2.3.3.1 Jumping directly to the source of a value with Go To Source or double-click

The **Go To Source** feature is a powerful and natural feature that allows you to find the source of an value without using the index pane at all.

There are two ways to use Go To Source:

- Double-click on an input on a CAD/CLD or block on a graphic
- **OR** Right-click on a point and choose **Go To Source** on the popup menu

Hyperview will automatically take you to the source of the input.

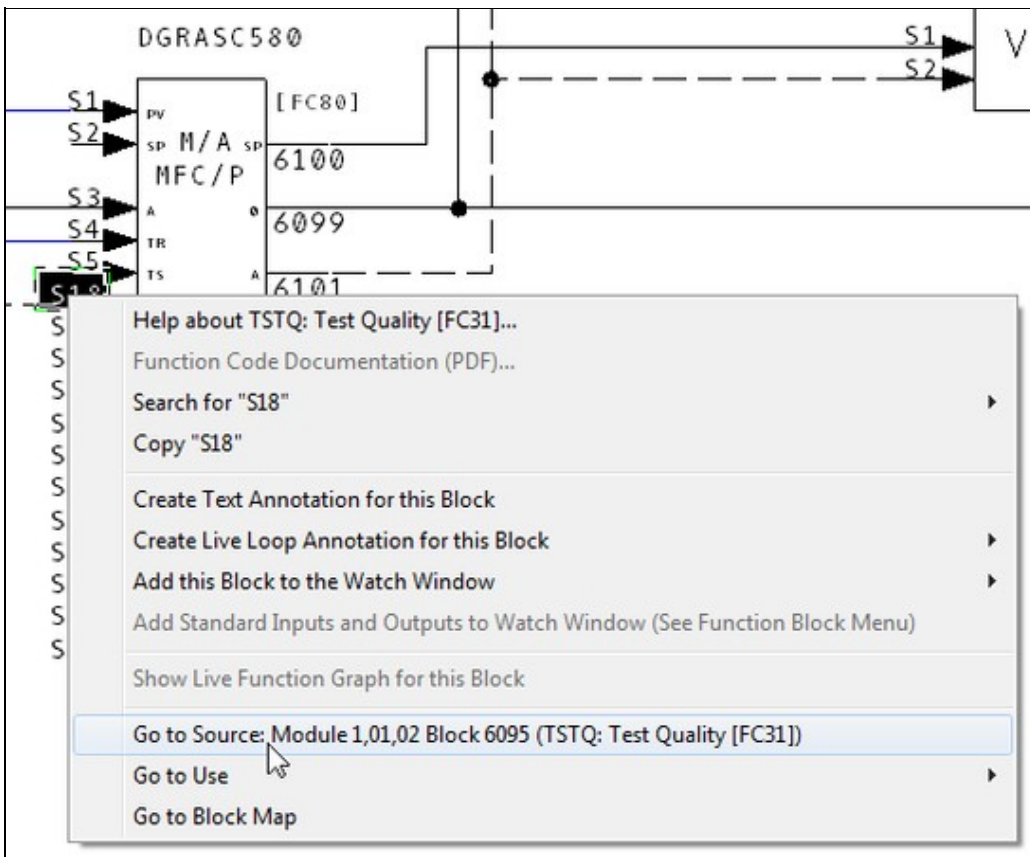

2.3.3.2 Jumping directly to a use of a value with "Go To Use" or double-click

To access any use of a block, right-click on the block's output or input and point to **Go to Use**, then click on one of the block's uses. If you have recently navigated to the block using **Go To Source**, the block from which you used **Go To Source** will be listed first.

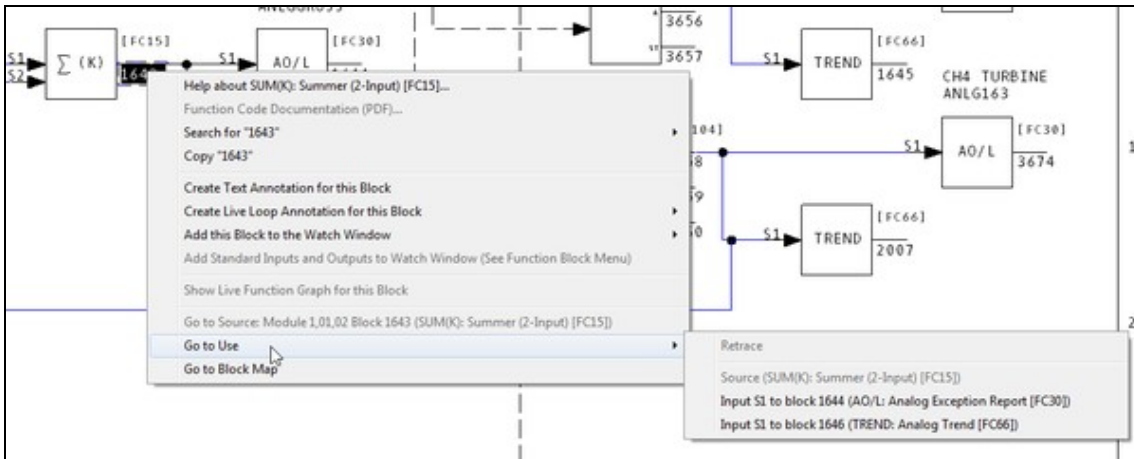

You can also double-click on an output to go to a use. This will take you to a use of the block as follows:

1. If there is only one use, or only one high-importance use, you will be taken to it automatically.
2. If you have recently navigated to the block using **Go To Source**, you will be taken to the block you used **Go To Source** from.
3. Otherwise, a popup menu will appear to let you select a use.

2.4 Full text, database, or title searches and search result navigation, and finding coordinates

2.4.1 Searching

When you build an project file with DBDOC, Hyperview can search it to find almost anything. There are three search options that you can use to find the information that you need:



Full Text Search



Database Search



Search all Titles

Just look for the **Big Binoculars**  and move your mouse over them. The button will change to reflect the last type of search that you did. Click on the button and the **Search** dialog will open to that particular type of search.

2.4.2 Text and database searches

2.4.2.1 Using Full Text Search to search your system for a word or phrase

Search for any word or phrase throughout the entire project, or restrict it to certain types of documents. To launch the Full Text Search utility, you can:

- Click the **Search** toolbar button , then click the **Full Text Search** tab
- **OR** Select **Full Text Search** from the Search menu
- **OR** Press **Ctrl+F** on the keyboard
- **OR** Select text in a document and right-click. Go to the **Search For Selection** option from the popup menu that appears and choose **Full Text Search**.

Search X

Full Text Search | Database Search | Search All Titles

Search phrase

Wildcards: '?' (any one character)
 '*' (zero or more characters)

Match exact phrase

Match each search term

Find any search term Find all search terms

Operators: AND, OR, NOT (upper case required)
 Quotes: "find this exact phrase"

Scope

All Topics

Current Topic

Groups

Groups:

- * Group: AutoCAD Sheets
- * Group: CAD/CLD Sheets
- * Group: Databases
- * Group: Graphics
- * Group: PDF Documents

Results display

Show Loop, PCU, Module, Block columns

Show Number of Hits per Topic

Show Hit Strings

Show Group

Maximum Number of Search Results (0 for no limit):

Multiple word search terms are automatically treated as if they are within quotes. For example, if you look for the term *condenser pump*, you will only find documents with the word **condenser** followed by the word **pump**. Documents that contain only one of the two words **condenser** or **pump** and documents where the word **condenser** is not immediately followed by the word **pump** will not show up.

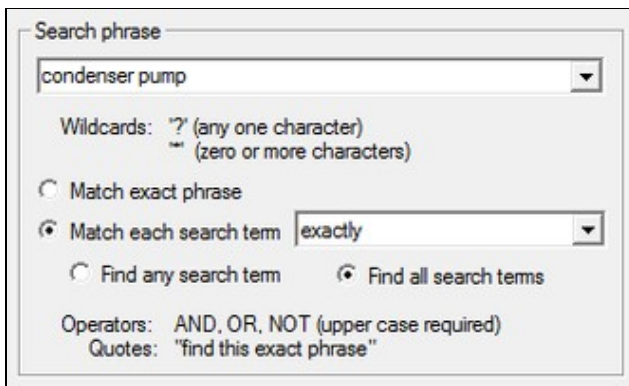

The screenshot shows a search dialog box with the following elements:

- A search phrase input field containing "condenser pump".
- Wildcards: "?" (any one character) and "*" (zero or more characters).
- Match exact phrase (radio button, unselected).
- Match each search term (radio button, selected) with a dropdown menu set to "exactly".
- Find any search term (radio button, unselected) and Find all search terms (radio button, selected).
- Operators: AND, OR, NOT (upper case required).
- Quotes: "find this exact phrase".

Match type drop-down list:

- **Match exact phrase:** searches for "**condenser pump**"
- **Match each term + exactly:** searches for **condenser AND pump**
- **Match each term + to the beginning of a word:** searches for **condenser* AND pump***
- **Match each term + to the end of a word:** searches for ***condenser AND *pump**
- **Match each term + to any part of a word:** searches for ***condenser* AND *pump***

 **Note:** The more wildcarding there is, the slower the search will be.



In **Match each term** mode, you can specify whether you wish search for **ALL** the terms, or **ANY** of the terms by selecting either

- **Find any search term**
- **OR Find all search terms.**

 **Note:** The logical operators **AND**, **OR**, and **NOT** and parentheses can be used in **Match each search term** mode. In **Match exact phrase** mode they will just be treated as ordinary text to match.

2.4.2.2 Using Database Search to find particular blocks or tags

A database search allows you to search the databases built into your project. To launch the **Database Search** utility you can:

- Click  or  on the toolbar and select the **Database Search** tab
- **OR** Select **Database Search** from the **Search** menu
- **OR** Press **Alt+D** on the keyboard
- **OR** Select text in a document and right-click. Go to the **Search for Selection** option from the popup menu that appears and choose **Database Search**.

Search ×

Full Text Search | Database Search | Search All Titles

Enter text in any box or boxes to find tags in the database.

Find tags with matching tag names
Example: 'ail' in this box will find all tags with 'ail' in the tag name.
Tag Name:
How to match:

Find tags by tag or trend index
Tag Index: Trend Index:

Find tags by Loop, PCU, Module or Block
Loop: PCU: Module: Block:

Find tags by text
Example: 'tank' in this box will find all tags with 'tank' in the tag description or other database text.
Miscellaneous Text:

Results display
 Show Loop, PCU, Module, Block columns
 Show Database
Maximum Number of Search Results (0 for no limit):

You can search by entering the tag index value, trend index value, tag name (or partial tag name) or any combination of Loop, PCU, Module and Block number. You can select any previously entered tag names or miscellaneous text from the drop down list. Miscellaneous text is very useful if you know part of the description field of what you are looking for but none of the above information.

2.4.2.3 Setting search options for text and database searches

For both **Full Text Search** and **Database Search**:

- **Show Loop, PCU, Module, Block columns** shows these attributes of a result topic, where applicable.
- **Show Number of Hits per Topic** shows you the number of times that your search item has shown up in one document.
- **Show Group** shows you the category to which your hit document belongs.
- **Limit the maximum number of search hits displayed** in each individual dialog box or set it on the **View** tab in the **Options** dialog.
- **Clear Search Hits** on the **Search** menu will remove all the highlight marks from the search results.

For **Full Text Search** only:

- **Show Hit Strings** shows the context in which a hit occurs (i.e. surrounding text)

2.4.2.4 Viewing search results for text and database searches

After you do a text or database search, you will see the following search results dialog:

[i90 demo daily build_20231017a_w2023-10-16-95526.dbdoc] Search Results

File

Searched for topics with the following text:
 tank (match exact phrase)

174 hits found in 87 topics; 87 of 87 shown

Topic Title	Loop	PCU	Module	Block	Group	Hits	Pane	Hit Strings
10102 Batch Files: 1010201a.b90 (STARCH CO...					Batch Programs, Module 1,01,02, 10102 ...	9	Right	[Click to show Hit Strings -- This may be slow!]
10102 Batch Files: 1010202a.b90 (SUGAR STUF...					Batch Programs, Module 1,01,02, 10102 ...	10	Right	{SUPPLY TANK 1 AGIT.}; {SUPPLY TANK 1 LEVEL}; {SUPP...
10102 Batch Files: 1010203a.b90 (JUICER #2 U...					Batch Programs, Module 1,01,02, 10102 ...	2	Right	{JUICE DAY TANK LEVEL}; CULATES THE JUICE USED BAS...
EVAMTR Ladder Program					Module 1,01,14, Logic	4	Left	[Click to show Hit Strings -- This may be slow!]
EVAMTR Ladder Program: Block 1124					Ladder Diagrams, Module 1,01,14, Logic	1	Right	Rung 281 BLK: 1124 XS-003,EVA FLASH TANK DISCHARC...
EVAMTR Ladder Program: Block 1126					Ladder Diagrams, Module 1,01,14, Logic	1	Right	Rung 283 BLK: 1126 XS-803,EVB FLASH TANK DISCHARC...
EVAMTR Ladder Program: Block 352					Ladder Diagrams, Module 1,01,14, Logic	1	Right	Rung 62 BLK: 352 24A-MSS-003 FLASH TANK DISCHARC...
EVAMTR Ladder Program: Block 356					Ladder Diagrams, Module 1,01,14, Logic	1	Right	Rung 66 BLK: 356 24B-MSS-003 FLASH TANK DISCHARC...
Exception Reported Values with Significant Change					Reports	5	Right	[Click to show Hit Strings -- This may be slow!]
Module 1,01,02 Block 1816	1	1	2	1816	Block Use Indices, Module 1,01,02	2	Left	NTRL STORAGE TANK LVL HI; Tag: DSKAH331 (NTRL S...
Module 1,01,02 Block 1831	1	1	2	1831	Block Use Indices, Module 1,01,02	2	Left	WASTER NEUTR TANK LEVEL; Tag: DSKI331 (WASTER...
Module 1,01,02 Block 2031	1	1	2	2031	Block Use Indices, Module 1,01,02	2	Left	WASTE HOLDUP TANK LVL HI; Tag: DSKAH380 (WASTE...
Module 1,01,02 Block 2040	1	1	2	2040	Block Use Indices, Module 1,01,02	2	Left	WASTE HOLDUP TANK LEVEL; Tag: DSKI380 (WASTE H...
Module 1,01,02 Block 2235	1	1	2	2235	Block Use Indices, Module 1,01,02	2	Left	DEMIN WTR/CNDS STRG TANK LVL; Tag: HBAI311 (DEM...
Module 1,01,02 Block 3116	1	1	2	3116	Block Use Indices, Module 1,01,02	2	Left	WASTE STOCK HOLD UP TANK LVL; Tag: DSKAH370 (DE...
Module 1,01,02 Block 3835	1	1	2	3835	Block Use Indices, Module 1,01,02	2	Left	DEAERATOR STRG TANK LEVEL; Tag: MSCI109 (DEAERA...
Module 1,01,02: 1010204A.CAD	1	1	2		CAD/CLD Sheets, Module 1,01,02	3	Right	STRG TANK LEVEL ; UP TANK LEVEL ; UP TANK LEVEL
Module 1,01,02: 1010205A.CAD	1	1	2		CAD/CLD Sheets, Module 1,01,02	1	Right	TANK LEVEL
Module 1,01,02: 1010206a.cad	1	1	2		CAD/CLD Sheets, Module 1,01,02	1	Right	TANK LEVEL
Module 1,01,02: 1010207A.CAD	1	1	2		CAD/CLD Sheets, Module 1,01,02	2	Right	TANK LEVEL ; STOR TANK PRESS
Module 1,01,02: 1010209A.CAD	1	1	2		CAD/CLD Sheets, Module 1,01,02	1	Right	DEAERATOR STRG TANK





Show Result Source
 Keep Open

Go To Print Show All Close Search

- **File:** Gives you the option to **Save** the search results to a file (a default filename is automatically supplied.)
- **Topics Containing Search Key:** Lists all the topics that met the search criteria. The list can be sorted based on Topic Title, group or hit frequency. You can jump to a topic by double-clicking on it.
- **Keep Open:** Keep the dialog box open after going to a document rather than automatically closing.
- **Show All:** If you have limited the number of search results to be displayed then you can press this button to display them all. This button will only be enabled if there are more search results to be shown.
- **Search Again:** Click to bring up the full text search dialog with all your previously specified search criteria filled in to narrow down your search hits.
- **Go To:** Go to the currently selected topic in the list.
- **Print:** Print the search results.

2.4.2.5 Displaying and stepping through search results using the Hyperview toolbar

There are a number of ways you can browse search results later, even after the **Search Results** dialog has been closed.

- Use the **Next Highlight**  and **Previous Highlight**  toolbar buttons to step through the search results in the document you are looking at.
- Click the **Search Results** toolbar button to bring up the list of search results
- Use the **Next Search Hit**  and **Previous Search Hit**  toolbar buttons to step through the documents that were found.

If no search hits were found, Hyperview will bring up an informational message box to let you know.

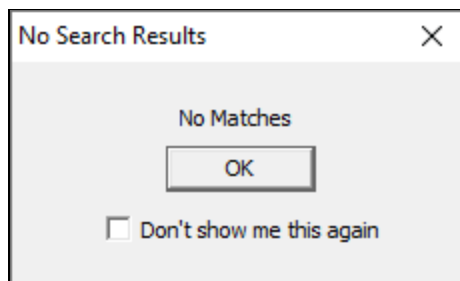

You can again choose to suppress this dialog from appearing the next time no matches are found by checking the **Don't show me this again** option before dismissing the option.



Note: If you click the box, when you search for something that is not found, you will simply see the search box remain as you launched it when the hourglass disappears. You can then easily try the search in a different way, but you have to realize that the search was done, but was unsuccessful.

2.4.3 Using the Topic Title Search to jump directly to a topic

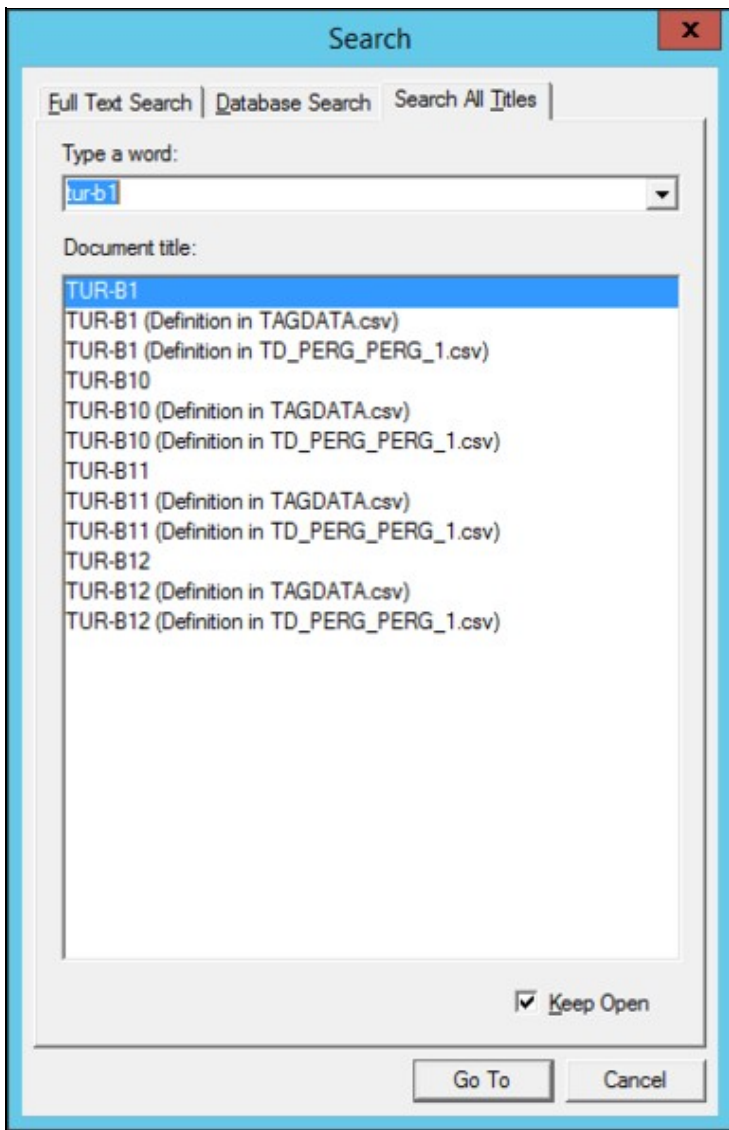
This highly convenient search mode makes it very quick and easy to jump to a topic of interest. Simply start typing the topic name. You will see a list of possible topics as you type. The more you type, the shorter the list will get. Double-click on one of the results any time to display it in the browser.



To launch the **Search All Titles** utility, you can:

- Click  or  on the toolbar and select **Search All Titles**.
- **OR** Select **Search All Titles** from the **Search** menu.
- **OR** Press **Alt+T** on the keyboard.
- **OR** Select text in any document and right-click. Go to the **Search For Selection** option from the popup menu that appears and choose **Search All Titles**.

Other useful tips by searching for title:

As you enter the document name, Hyperview narrows the scope of the match. **Module LL,PP,MM Block NNNN** is a topic. **NNNN** will give you Conductor NT graphics by number. Select the document you want and click the **Go To** button, press return, or double-click on the selected document.

- **Keep Open:** Check this option to keep the dialog box open after going to a document rather than having it automatically close.

2.4.4 Advanced: Finding a Coordinate

You can also enter a coordinate set to go to on a specific document - a helpful feature for finding messages reported in the DBDOC.ERR files.

Spot the blinking red ball! Find the coordinates you are interested in on a given document easily without having to scroll through it. Hyperview will go directly to the coordinates entered and zoom in.

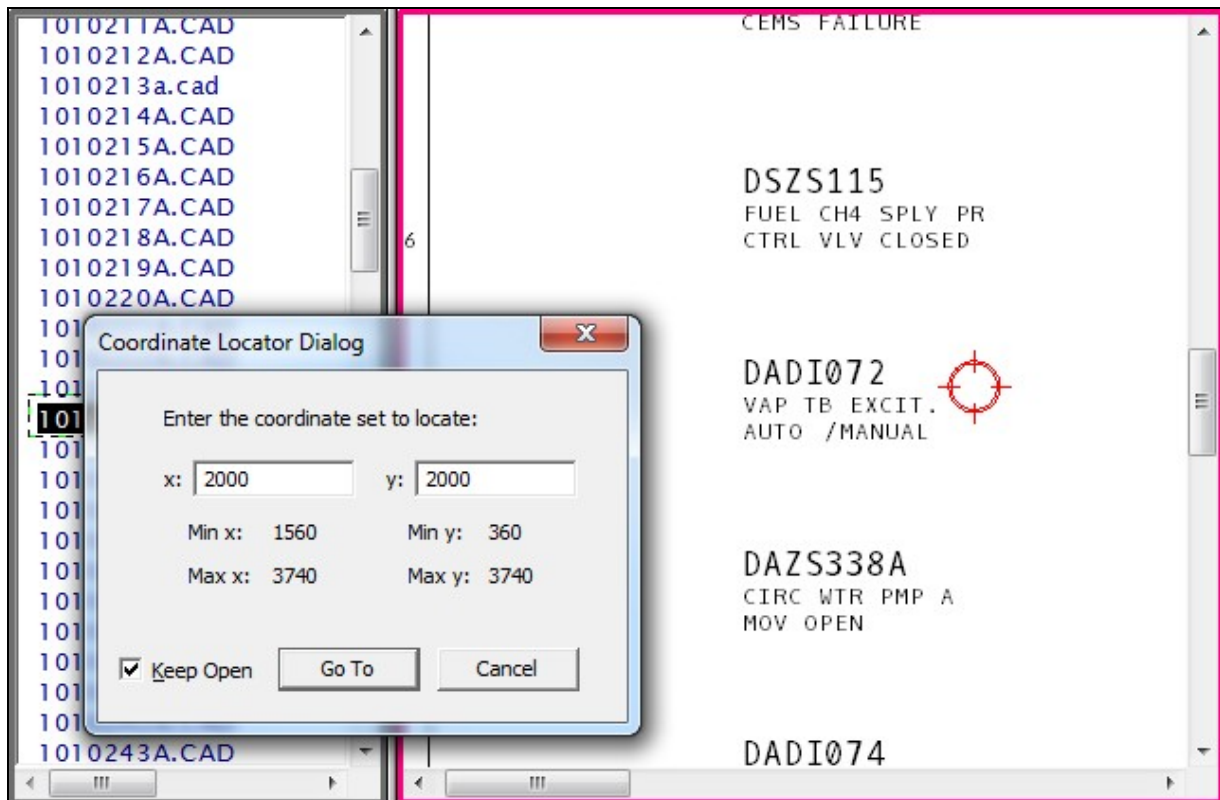

Two ways to bring up the coordinate locator:

- Select **Find Coordinate** under the **Go** menu option - enter the coordinate set that you want to go to on the current document.
- **OR** Right-click on the drawing to bring up the popup menu and select **Find Coordinate**.

When launched via the **Go** menu or the popup menu, the coordinate locator dialog displays the minimum and maximum x and y values on the current drawing. The minimum values or the last entered coordinate set are automatically filled into the edit boxes.

A message will appear when you enter a value that is out of range. Negative values are accepted where applicable.

Cancel the coordinate locator by double-clicking on it.

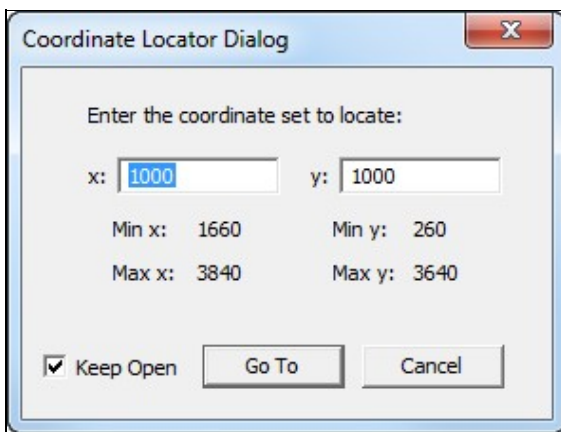



Check the **Keep Open** option to keep the dialog open after the **Go To** button has been clicked. This is useful if you are iterating to pinpoint an exact coordinate set.

2.5 Guide to Live Data on Documents

2.5.1 Live Data Monitoring

Hyperview provides read-only access to limited amounts of live data. Hyperview will display the data for individual blocks as well as displaying analogue values in bar graphs where called for on graphics.

There are three ways to fetch live data from your system:

-  **Slow Mode (Camera)** - preferred in general
-  **Continuous Mode (Clock)**
-  **Live Loop Annotations** - live data for individual points

2.5.1.1 Using Slow Mode live data

To take a snapshot of the live data for all the outputs in the viewing area, click on the Slow Mode button  on the toolbar. Hyperview will fetch the values of the outputs displayed. Click the camera button again to fetch the live data values on the display again.

- Slow Mode will remain on until it is turned off by double-clicking the Slow Mode Button.
- When you view a different document, the values for it will be fetched automatically.
- If you scroll or zoom on the current document, Hyperview will automatically refresh the values.
- If you do not scroll, zoom, or change documents, Hyperview will refresh the values every ten seconds.

The shortcut keys used for Slow Mode are listed below:

- **M** - Turns on Slow Mode and will fetch all values on the CAD or CLD sheet you are viewing. Pressing **M** successively will refetch the data on the sheet you are viewing.
- **Shift+M** - Turns off Slow Mode.
- **F5** - Refetches the values on the CAD or CLD sheet you are viewing.

2.5.1.2 Getting live data in Continuous mode

You can activate **Continuous mode** live monitoring of your system by clicking on the **Live Loop Display** button  or selecting the option from under the **View** menu.

- Hyperview will send out requests at the desired frequency (by default, every second) for data for all visible points in the drawing pane.
- The update interval can be changed in the **Options** dialog.

 **Note: On dynamic bar graphs:** The color of the bar displayed will indicate the status of the data. The colors of the status bar are as follows:

- **Valid:** bar will be green.
- **Stale or unavailable:** the bar will be drawn in red crosshatch.
- **Bad quality:** bar shown in the user specified bad quality color.

 **Note:** If you attempt to monitor without having any live loop settings entered, Hyperview will automatically alert you and give you the opportunity to enter settings at that point. This helps to take the guesswork out of why you would not be seeing live data!

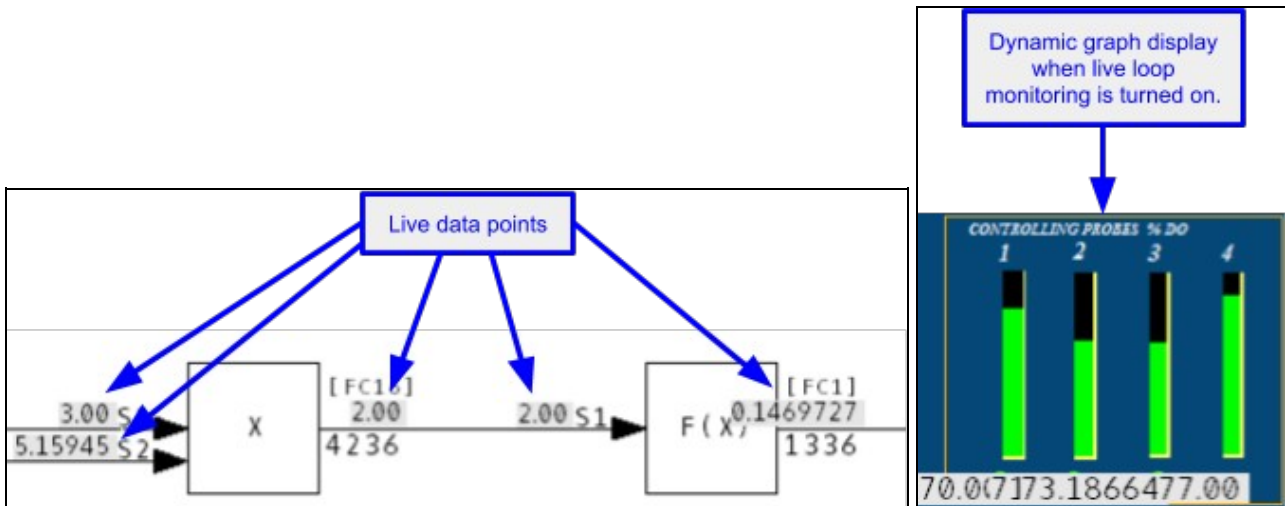

2.5.1.3 Managing the Slow Mode Data Load

In **Slow Mode**, data is fetched automatically every ten seconds, and when you move the screen, zoom, or go to another document, or explicitly refresh the values, providing an excellent balance between having the most relevant up-to-date data, and not overloading the data bandwidth available. For most purposes, **Slow Mode** will be the best option for minimizing data load due to on-document live data.

Slow Mode tips:

- Double-click the camera button to turn off **Slow Mode**. **Slow Mode** is never turned off automatically.
- On graphics, zoom in to the area you are interested in. Data is only fetched for visible points. If you do not zoom in, it may take Hyperview several seconds to fetch data for the entire graphic.
- Switch to CAD / CLD sheets sooner rather than later. This will further reduce the amount of data fetched.

If you use Slow Mode, you will leave a lot more bandwidth for other Hyperview users.

2.5.2 Live Loop Annotations

Live Loop Annotations are "sticky notes" displaying live data. You can add them to any document. You can create a **Live Loop Annotation** to display live data for any block in your system, or module status for any module. **Live Loop Annotations** are a convenient way to monitor block values, or module status for one part of your system while looking at a different part of the system in Hyperview, or to display live data for just a few items on a document.

You can place **Live Loop Annotations** on any document that you can view in Hyperview's content pane, including graphics, text files, and database entries. If you want to monitor live data independently of what document you happen to be viewing, consider using the **Watch Window** instead.

Live Loop Annotations are automatically saved, and will reappear on the documents where you created them the next time you open Hyperview, even if you switch to a new build of your system. So if you always need to refer to a certain block value while viewing a particular document in Hyperview, **Live Loop Annotations** will let you do just that.

Standard live loop annotation:

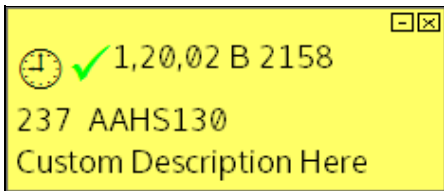

Live loop annotation with dynamic bar:

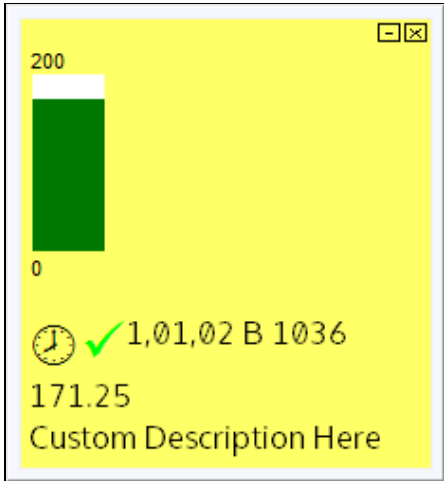

Live loop annotation with data specs:

 **Note:** As of DBDOC 11.1 this type of annotation has been replaced by **Live Specs**.

Live loop annotation with module status:

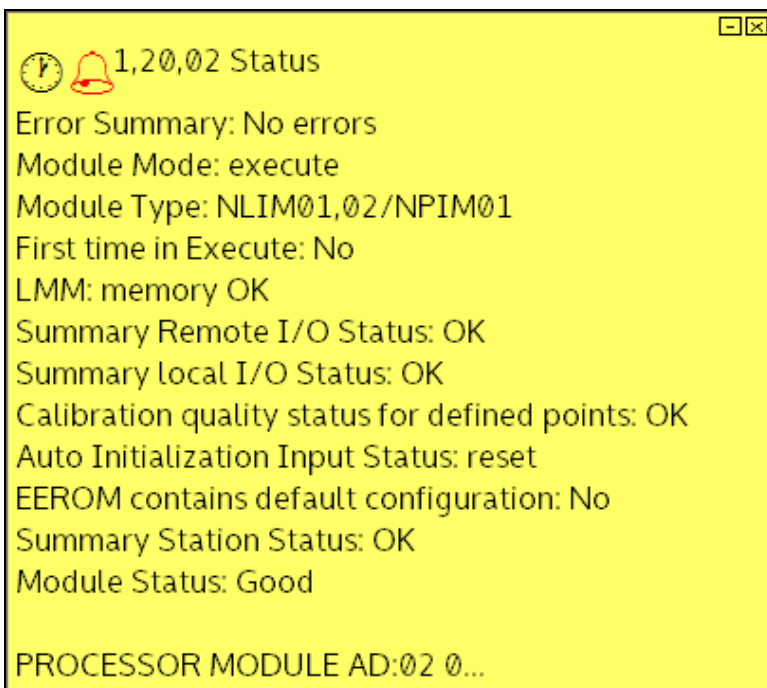

Use live loop annotations to:

- View live loop data for just one block in your system.
- Monitor live loop data from any Hyperview document.
- View the live module status for any module in your system.

For example, you can easily use **Live Loop Annotations** to keep track of the value of a tag, while viewing that tag's database entry.

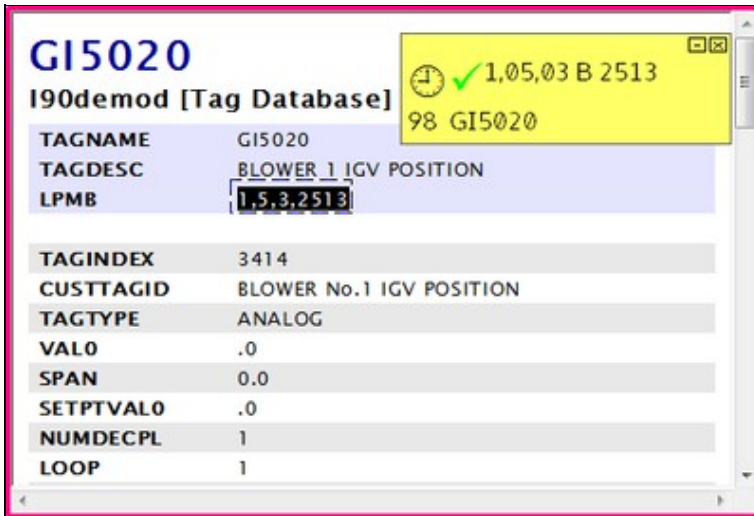

To view help on **Live Loop Annotations**, right-click any **Live Loop Annotation**, then click **Help**.

2.5.3 Creating a Live Loop Annotation

The **Live Loop Annotation** dialog is used to specify a value to monitor and to set or change the options for a **Live Loop Annotation**.

Live Data Options For This Block ✕

Specify Value to Monitor:

Value For Block Number
 Loop: PCU: Module: Block:

Value For Tag Name
 Tag Name:

Tag Name	Loop	PCU	Module	Block	Description
< >					

Module Status
 Loop: PCU: Module:

Basic Options

Description:

Update Interval: Seconds

Annotation Options

Dynamic Bar

Watch Window Options

Display

Reverse Y-axis
 Color:

Schedule

No scheduled pause

Plot or Dynamic Bar Range

Built-in Range to

Auto Range (calculated on the fly)

Specify Range to

The **Live Loop Annotation** dialog is used to specify a value to monitor and to set or change the options for a live loop annotation.

There are three ways to specify the point that you wish to monitor:

- By creating the live loop annotation on a hotspot
- By entering the block number
- By entering a tag name

You can also monitor the status of a module.

To create a **Live Loop Annotation** on a hotspot:

- Click the **Live Loop Annotation** toolbar button  then click the

hotspot. A **Live Loop Annotation** displaying the output value of the block will be created.

OR

Right-click on the hotspot, point to Create Live Loop Annotation for this Block, then click one of:

- **Show Value**
- **Show Dynamic Bar**
- **Live Loop Annotation** dialog

Choosing the **Live Loop Annotation** dialog will allow you to change settings such as the update interval and the dynamic bar range. The other three options will create a **Live Loop Annotation** with the default settings.

You can create a live loop annotation on any hotspot with LPMB information, including on text documents and batch files.

To create a live loop annotation that is not on a hotspot:

- Click the **Live Loop Annotation** toolbar  button , then click the point on the content pane where you would like to place the live loop annotation.

The live loop annotation dialog will appear so that you can specify which point to monitor.

To specify which point to monitor by loop, PCU, module and block number:



1. Click **Value for Block Number**.
2. Enter the appropriate information in the LPMB boxes.

To specify which point to monitor by tag name:

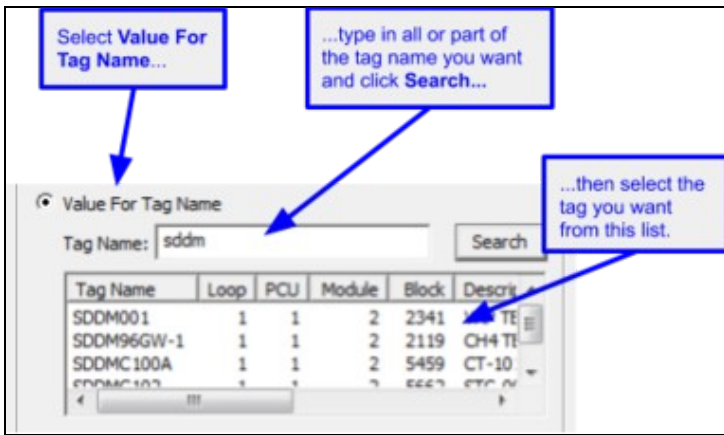

1. Click **Value For Tag Name**.
2. Enter part or all of a tag name in the **Tag Name** box and press the **Search** button. Hyperview will look through the databases and present any matching tags in the list.
 1. You can enter pseudo-tags to look for a particular point (e.g tagname@PV)
 2. If you leave the Tag Name box blank, the search results will contain all tags in all databases in the project.
3. In the search results list, click the tag name which you wish to monitor.

To monitor the status of a module:

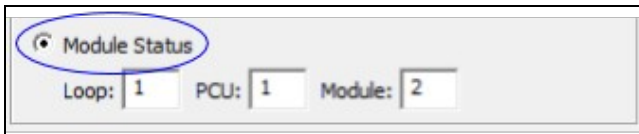

1. Click **Module Status**.
2. Enter the appropriate information in the **LPM** boxes.

2.5.3.1 Block Options (for either Live Loop Annotations or Watch Window Blocks)

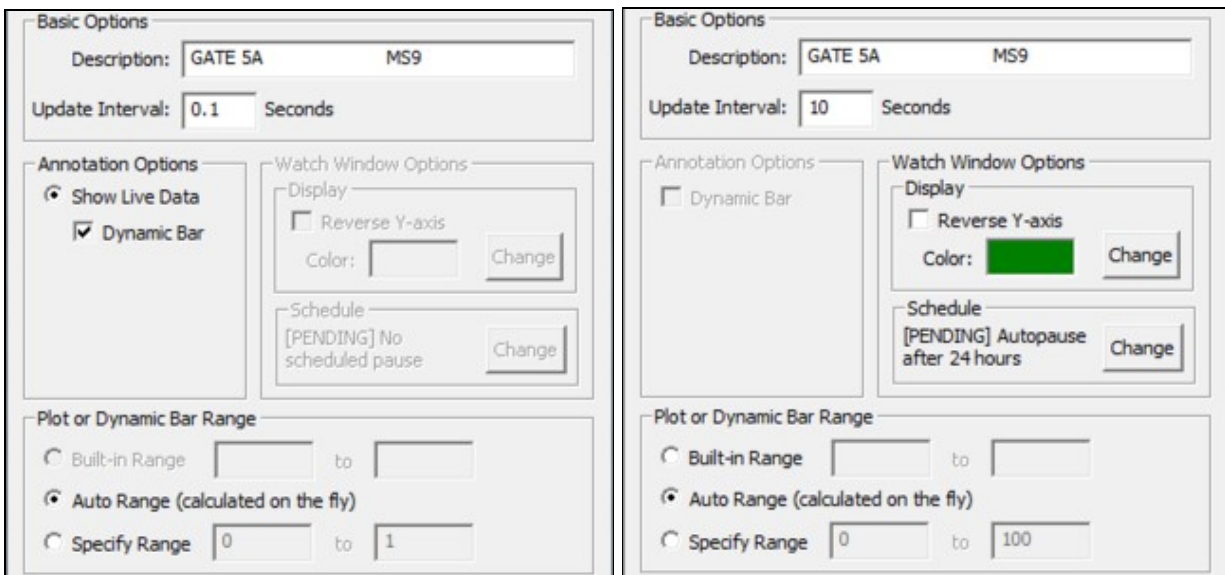

2.5.3.1.1 Basic Options

- **Description:** This text will be displayed when the mouse is hovering over a live loop annotation.
- **Update Interval:** The amount of time, in seconds, that the live loop annotation will display each value before fetching a new value. The default interval for new annotations is one second. This default can be changed in the **View** tab of the **Options** dialog (see p.58).

2.5.3.1.2 Annotation Options

- **Show Live Data:** If this is selected, the live loop annotation will show the current output value of the block as a number.
- **Dynamic Bar:** If this is selected, the live loop annotation will show the current output value of the block as a bar graph and as a number.

2.5.3.1.3 Watch Window Options







- **Reverse Y-Axis:** Reverse the vertical axis for the plot.
- **Color:** Change the plot line color for the selected block.
- **Schedule:** Set an automatic data collection timeout for the specified block. Blocks can be manually paused and restarted, as before, but starting in version 10.4.1 automatic timeouts can also be set. A block can be configured to automatically stop collecting data after a certain interval, for example 24 hours, or at a specified time.

2.5.3.1.4 Plot or Dynamic Bar Range

- **Built-In Range:** This option is only available if **Dynamic Bar** is selected and the block has minimum and maximum values specified in one of the project databases. If this option is selected, the minimum and maximum values from the database will be used for the limits of the bar graph.
- **Auto Range:** This option is only available if **Dynamic Bar** is selected. If this option is selected, the bar graph limits will adapt to the data fetched.
- **Specify Range:** This option is only available if **Dynamic Bar** is selected.. If this option is selected, the bar graph will have the limits you specify here.

2.5.3.2 Reading Live Loop Annotations

You may see the following symbols and abbreviations on live loop annotations:

	Successful data fetch
	Error
	Bad quality
	Alarm
	Info - the version of CIUMon that you are currently using to monitor with has been configured for a certain loop and PCU and the point that you are requesting data for does not match that configuration.
	The IP address of the computer you are currently monitoring from has not been approved by CIUMon to fetch live data. You will also see IP_BLOCKED displayed in the manual live loop data window.

H	High
L	Low
D	Deviation
C	Calibration
S	Service

If the symbols on an LLA are greyish, this indicates that the data is stale.

2.5.3.3 Managing Live Loop Annotations

You can view a complete listing of all live loop annotations by:

- Clicking the **Manage Annotations**  button on the toolbar
- **OR** Selecting **Manage Annotation** from under the **View** menu and clicking the **Live Loop Annotations** tab.

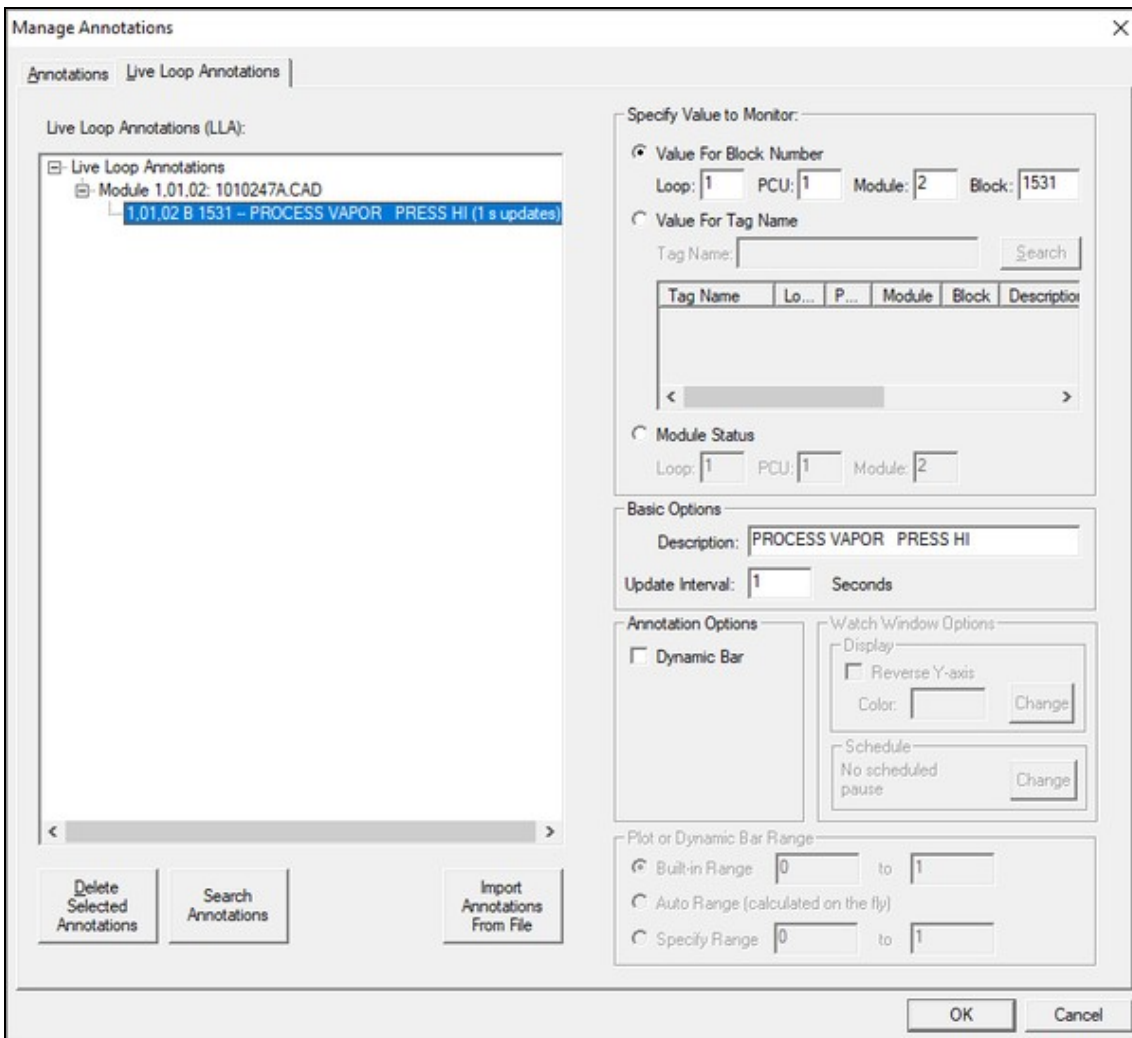

For a selected annotation, you can:

- Change what value it is monitoring.
- Change any of the options, including **Mouse-over text**, **Update Interval**, and **Dynamic Bar** settings.

2.5.3.4 Moving Live Loop Annotations

To temporarily move a live loop annotation, click and drag it to a new position. It will be linked to its permanent position by a thin line, or "rubberband". If the annotation was created on a hotspot, the rubberband is useful as a pointer to that hotspot.

To move an annotation back to its permanent position, double-click it.

To minimize a live loop annotation, click the **Minimize** button  on its upper right hand corner.

To permanently move a live loop annotation, minimize it, then click and drag the minimized annotation to a new position.

2.5.3.5 Deleting Live Loop Annotations

To delete a live loop annotation from the content pane:

- Click the **Delete** button  on the live loop annotation's upper right hand corner.
- **OR** Right-click the live loop annotation, then click **Delete Live Loop Annotation**.

To delete live loop annotations using the annotation manager:

- To delete a single live loop annotation, select it in the list of annotations, then click **Delete**.
- To delete all live loop annotations on a topic, select the topic in the list of annotations, then click **Delete**.
- To delete all live loop annotations in the entire project, select the top entry in the list of annotations, then click **Delete**.

2.5.4 Live Specs

Live specs can be turned on in the **View** menu by selecting **Enable Live Specs**. On layered specs, live spec values will then be displayed directly. Prior to DBDOC 11.1, these live specs would have to be displayed as their own type of live loop annotation.

Just as with refreshing live data values in Slow Mode, clicking the camera in the bottom right of the specs will refresh the values. Unlike in Slow Mode, these specs do not update automatically over time.

Live specs appear in two places: in the layered spec rectangle, and on the inputs.

1. General specs

- ◆ Appear in a large movable rectangle.
- ◆ Black text means the spec's live value is same as its static value.
- ◆ Green text means the spec's live value is different from its static value (probably not an error, though).

2. Input specs

- ◆ Appear as small rectangles around each of a block's inputs.

- ◆ A green rectangle means the spec's live value (i.e. the block number of the input) is the same as its static value.
- ◆ A red rectangle means the spec's live value (i.e. the block number of the input) is different from that implied by the wiring. This could well be unexpected, and so it is highlighted.

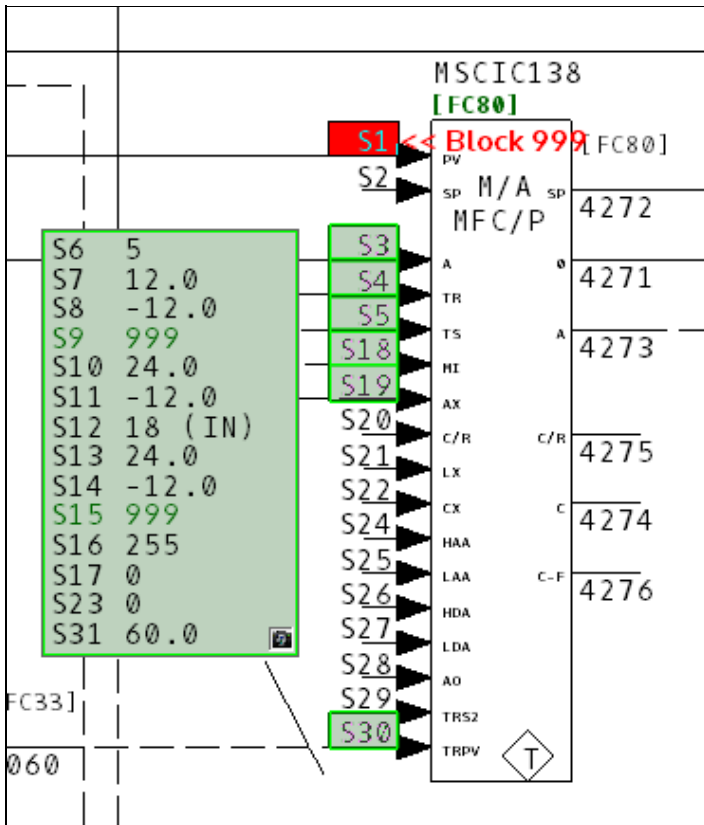

2.6 Trending Live Data in the Watch Window

2.6.1 Watch Window Overview

The Watch Window allows you to plot live data from one or more points in the same window. It helps troubleshoot problems and analyze the way the system works. Add blocks from anywhere in the system to a window that displays their values in an easy to use plot. Control the range, resolution and data collection rate of each block.

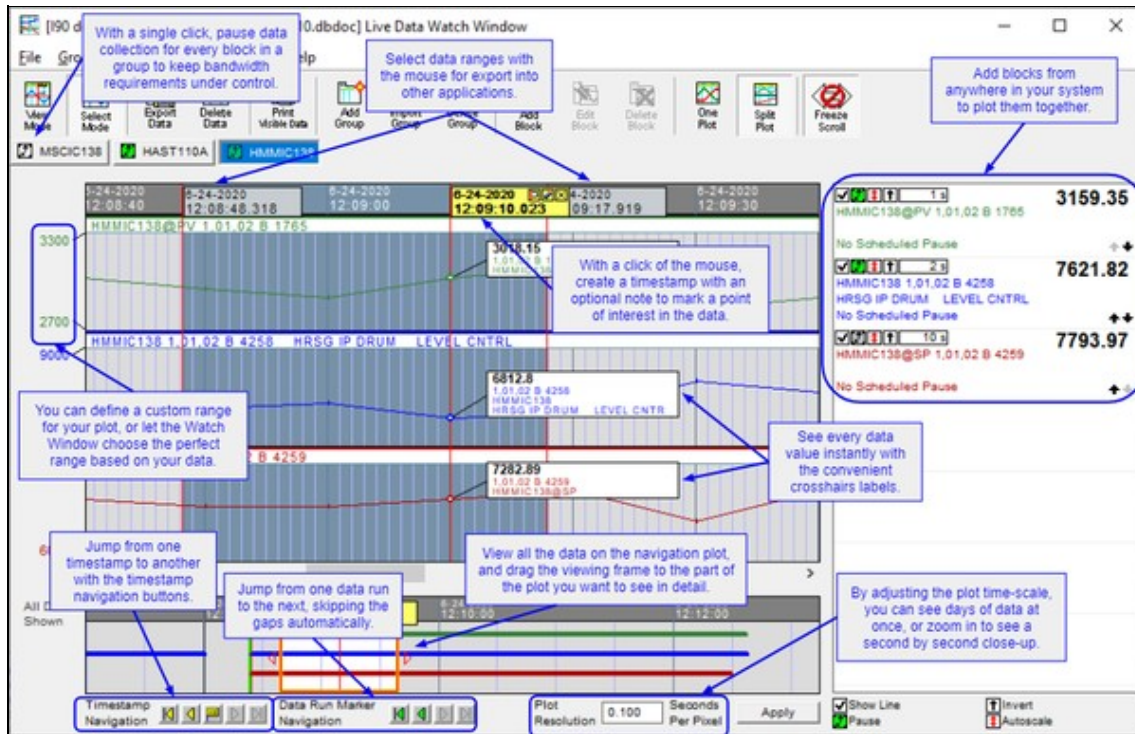

2.6.1.1 Using the Watch Window: quick summary

- Adding a block to the Watch Window can be done effortlessly by right-clicking on a block and selecting **Add this Block to the Watch Window**.
- Once a block has been added to the Watch Window, it will begin collecting data. As you move the mouse over the plot, crosshairs appear showing you exact data values.
- Click on the plot to place a **Timestamp** showing the value and time of a point of interest.
- Blocks are added in **Split Plot** mode with **AutoScaling** enabled. This gives you a natural starting point. One click and you display them in one plot. One click and you rescale the plot of the value.
- You can easily walk through Timestamps by using the **Back** and **Forward Navigation** buttons at the bottom of the Watch Window.
- Using the Block List, you can hide the plot for a block by unchecking the checkbox on the left-hand side. Autoscaling and pausing data collection for a block can also be enabled using the Block List.
- Using our simple **Export Data** tool, you can export the data for the group for a selected group into a .csv file for import into Microsoft Excel® or other external applications.

2.6.2 Opening the Watch Window

You can open the watch window from the Hyperview window in three ways:

- Click the **Live Data Watch Window** button  in the toolbar.

- Press **W** on your keyboard.
- Click **View | Watch Window** in the main menu.

2.6.3 Adding blocks to the Watch Window so they can be plotted

There are several ways to add a block to a group in the watch window:

1. On any CAD, CLD, graphic, AutoCAD or Microstation drawing, right click on any source or output hotspot and select **Add this Block to the Watch Window**. The point will be added with the default options to the watch window group you choose.
2. Right click on any live loop annotation and select **Add to Watch Window**. The point will be added to the watch window group you choose using any live loop annotations options you already entered.
3. In the **Live Data Watch Window**, click the **Add Block** button and define the block you wish to add.
4. In the **Live Data Watch Window** menu, choose **Block > Add** and define the block you wish to add.
5. Right-click on any block in the block list and choose the **Add Block** menu option.
6. Right-click on a blank area of the block list and choose **Add Block** from the menu.

2.6.4 Defining and editing block plots in the Watch Window

If you are specifying a block to add to the Watch Window by block number or tagname, or editing options for an existing block in the Watch Window, you will use the **Block Live Data Options** dialog.

Live Data Options For This Block ✕

Specify Value to Monitor:

Value For Block Number
 Loop: PCU: Module: Block:

Value For Tag Name
 Tag Name:

Tag Name	Loop	PCU	Module	Block	Description
< >					

Module Status
 Loop: PCU: Module:

Basic Options

Description:

Update Interval: Seconds

Annotation Options

Dynamic Bar

Watch Window Options

Display

Reverse Y-axis

Color:

Schedule

[PENDING] Autopause after 24 hours

Plot or Dynamic Bar Range

Built-in Range to

Auto Range (calculated on the fly)

Specify Range to

To edit the options of an existing block with a plot in the Watch Window:

- Double-click the block in the Block List on the right hand side of the Watch Window..
- Right-click the block in the Block List and choose **Edit**.
- Select the block in the Block List and click the **Edit Block** button.
- Select the block in the Block List and choose **Block | Edit** from the menu.

The **Edit** dialog that appears is the same as that which is discussed in the section of the **User Guide on Live Loop Annotations**.

2.6.4.1 Specific Watch Window Options

The following block options are specific to Watch Window blocks.

- **Reverse Y-Axis:** Reverse the vertical axis for the plot.
- **Color:** Change the plot line color for the selected block.
- **Schedule:** Set an automatic data collection timeout for the specified block. Blocks can be manually paused and restarted, as before, but starting in version 10.4.1 automatic timeouts can also be set. A block can be configured to automatically stop collecting data after a certain interval, for example 24 hours, or at a specified time. If you like, by checking **Confirm before pausing** you can require that Watch Window obtain confirmation before automatically pausing data collection for any block.

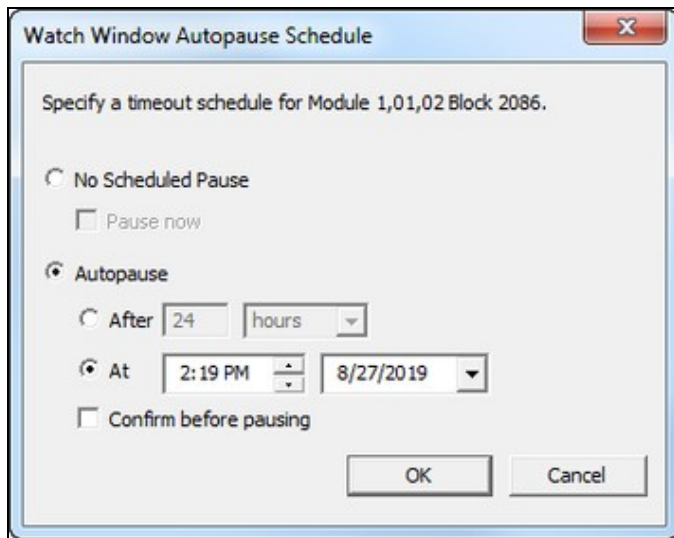

2.6.5 Creating groups of blocks in the Watch Window

Create different groups of points to keep your watch window uncluttered. Make sure to specify a unique name for each group that you create. Create a new group by clicking on the **Add Group** button or choosing **Add** from the **Group** menu in the Watch Window. This will give you an empty group to which you can start adding the blocks that you want to monitor.

2.6.5.1 Importing a list of blocks from CIULink

If you are monitoring blocks using **CIULink**, you may want to transfer them to the Watch Window.

Import a taglist created in CIULink as a group. Choose the **Import** option from the **Group** menu or click the **Import Group** button.

You have the choice of browsing for an exported .LST file created by CIULink or choosing from the list of CIULink taglists that are currently stored in the registry.

The group will be populated with all the points in the chosen taglist - saving you from having to enter each point individually.

2.6.5.2 Managing groups of blocks

Manage your groups:

- Through the **Group** menu in the watch window.
- With the various Group buttons available on the Watch Window toolbar.
- By right-clicking the on the group tab name and selecting the appropriate action from the menu.

2.6.6 Watch Window Highlights





- **Crosshairs:** As you mouse over on the plots, you will see red crosshairs appear for each block that you are monitoring. The LPMB information and the data value will appear next to the crosshair making for easy interpretation of the plotted value. To leave a timestamp so are able to return to a point of interest just click the mouse. These stamps will persist as the Watch Window collects new data. They can be deleted by clicking the **X** in the top right-hand corner. In addition, you are able to move through the crosshairs by using the navigation button at the bottom of the Watch Window.
- **Navigation Plot:** A second timestrip-type plot below the main plot displays all the data that has been collected for the group. The beginnings and ends of data runs are indicated with green and red flags, and you can jump from flag to flag by using the **Data Run Marker Navigation** buttons below the navigation plot.
- **Freeze Scroll:** By clicking on the **Freeze Scroll** button located at the bottom left of the watch window or dragging the horizontal scroll bar, the plot will freeze, allowing you to look at the any portion of the data without having it continuing to scroll to the left. The background of the plot will change from white to a light gray to indicate that the scrolling is frozen. To unfreeze the scroll, click the **Freeze Scroll** button and the plot will jump to the current time.
- **Plot Time Scale:** You can adjust the time scale against which the plot is drawn; by default, the value is 1.00 sec/pixel. You can expand the plot by entering in a smaller value or compress it by entering a larger number in the Plot Time-Scale field. Enter the desired value in the field and click the **Apply** button or just press **Enter**.
- **Split Plot:** Split plot allows each block to be placed onto its own separate plot to be graphed separately. If you look on the left-hand side the range of values being graphed is shown at the top and bottom of the plots. This gives you a better view for analyzing your data.
- **Always keep the Watch Window visible:** Under the **Options** menu in the watch window, check the **Always display Watch Window on Top** option so that the window will float on top of all other windows and will always be visible to you.
- **Exporting Data:** You are able to select which data you wish to export from the Watch Window. By pressing the **Select Mode** button on the toolbar, it will allow you to drag the mouse pointer to select the data you wish to extract for further analysis. Once you have made your selection, press the **Export Data** button, which will confirm your selection and export the data to a CSV file. The data in

the CSV file displays very nicely in **Microsoft Excel**.

- **Go To Source or Go To Block Map:** These options are available by right clicking on a block in the block list. **Go To Source** will take you to the CAD or CLD sheet where the block is used. **Go To Block Map** will take you to that block's entry on the Block Map.

2.6.7 Timestamp Navigation

Timestamp Navigation buttons make the task of navigating through timestamps much easier.



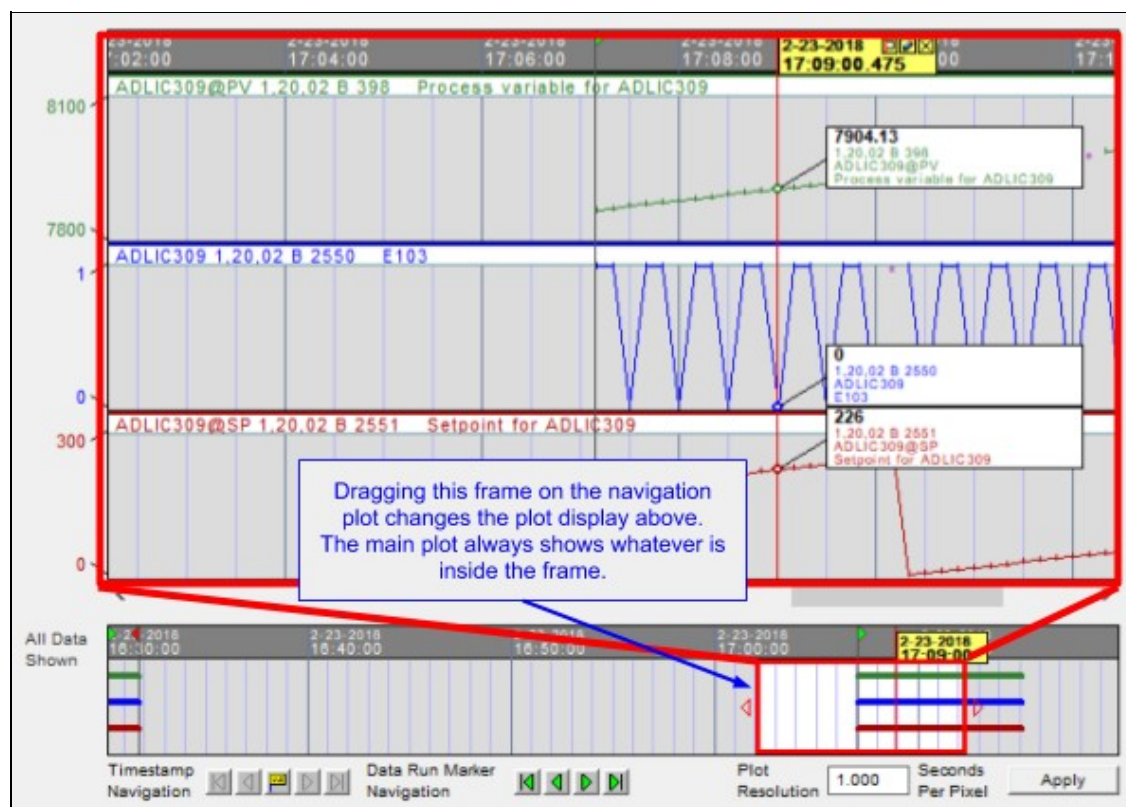

-  Jump to the left-most timestamp on the plot.
-  Jump to the previous (next left) timestamp on your plot.
-  Jump to the currently selected timestamp.
-  Jump to the next (next right) timestamp on your plot.
-  Jump to the right-most timestamp on your plot.

2.6.8 Data Marker Navigation

A navigation plot below the main plot makes it easy to move through different datasets collected at different times.



With the **Data Run Marker Navigation** buttons you can step through data collected at different times.

-  Jump to the left-most data run marker.
-  Jump to the previous (next left) data run marker.
-  Jump to the next (next right) data run marker.
-  Jump to the right-most data run marker.

2.6.9 Managing Watch Window related bandwidth, and disk usage

These topics are covered briefly here, and in more detail in the User Guide chapter *Guide to Managing Live Data Load and Increasing Live Data Bandwidth*.

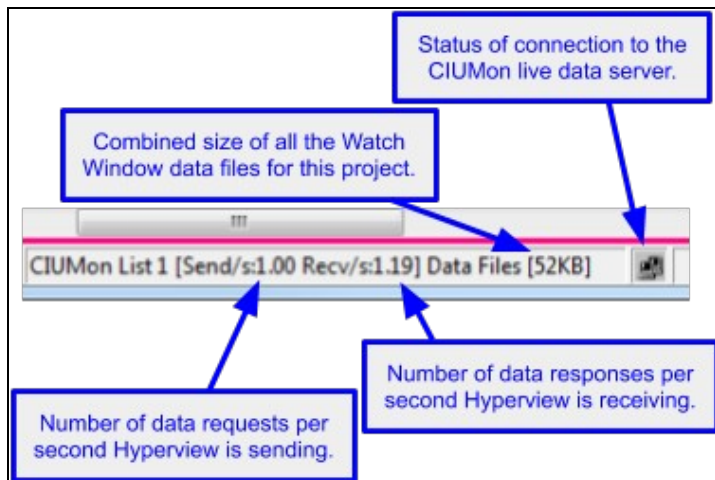

This **Live Data Status Bar** provides useful information regarding how many data update requests are being made per second, how many updates are received, how much memory is being used for the Watch Window plots, and how much disk space is being used for Watch Window data files.

2.6.9.1 Bandwidth

In general, a CIU is able to provide responses to no more than 30 requests per second. If multiple users are sharing one CIUMon to CIU connection, they will be limited collectively by that data bandwidth.

With a bit of care, you will be able to use the full power of the Watch Window without overwhelming the limited bandwidth available. Here are some tips to keep the Watch Window data fetch rate from being any higher than necessary:

Tips for managing Watch Window data bandwidth:

- Look at **Send/s** and **Recv/s** in the **Live Data Status Bar** at the bottom of the main Hyperview browser to see what data requests Hyperview is sending and receiving.
- If **Send/s** is larger than **Recv/s**, data updates are not "keeping up" with requests. Consider reducing the data load.
- Be aware of the data update requests being generated by the main browser window. Consider turning off live data in the main browser or switching to **Slow** mode .
- Be aware that the Watch Window collects data even when it is not open.
- When you add a block to the Watch Window, it will fetch new data once every 10 seconds. If you don't need to collect data that frequently, increase the update interval.
- If you don't need the data from a block, but wish to keep it defined in the Watch Window, pause data

collection for that block.

2.6.9.2 Memory

Prior to DBDOC 10.4, Watch Window plot data was stored in memory. If a very large amount of data had been collected, this could affect performance.

As of DBDOC 10.4, trend data is loaded for display on an as-needed basis. Large datasets will not cause the general memory requirements of Hyperview to increase.

2.6.9.3 Disk Usage

All data collected in the Watch Window is automatically saved to CSV files. Over time, these files can become large.

Tips for managing Watch Window memory use:

- Look at **Data Files** in the **Live Data Status Bar** at the bottom of the main Hyperview browser to see how much disk space is being used for Watch Window data files (including those not currently in the Watch Window).
- Deleting data from inside a plot (i.e. by selecting it and deleting it) in the Watch Window will remove it from memory **and also from the data files**.
- If necessary, you can delete the data files directly. See Guide to Managing Live Data Load and Increasing Live Data Bandwidth for details on their location.

2.6.10 Importing data into other applications

The best way to use Watch Window data in other applications is to export it. It should rarely if ever be useful to use the raw data file directly.

How to export data:

- Select the data in the Watch Window you wish to export. Data for all the visible plots in the visible group will be exported. Hiding a plot will prevent it from being exported.
- Press the **Export Data** toolbar button. You will be able to choose the interval size for the exported data and the file to which the data should be saved.
- You will have the option of viewing the data immediately in the application associated with CSV files on your system, typically Microsoft Excel.

2.7 Viewing and Managing System Errors with the Error Browser

2.7.1 Error Browser Overview

The Error Browser is a powerful tool that allows you to easily examine the errors in your system configuration that DBDOC detected while compiling your project. Because DBDOC integrates information across many sources throughout the system, it is in a position to detect inconsistencies and possible problems, ranging from serious errors to cosmetic issues. For many years, these errors have been available for viewing in compiler generated text files, but as of DBDOC 10.5 they are presented in Hyperview in a dedicated error browser. This enables you to click on errors to jump directly to the associated location in the project file, review errors methodically, and hide errors that you don't need to see. Errors can be filtered, sorted, and grouped in a variety of ways to help you get a handle on them.

The screenshot shows the Error Browser interface with several callout boxes explaining its features:

- Choose which errors to show: All, Starred, Reviewed, Hidden etc.** (points to the 'Show these errors' dropdown menu)
- Add stars to errors to flag them for further review.** (points to the star icon)
- Mark errors as "reviewed" when you've looked at them.** (points to the checkmark icon)
- You can hide errors that don't require further review.** (points to the trash can icon)
- The error tree can be organized in many ways, including by error type, severity, document the error occurs on, Loop, Module, PCU, associated function code, and more..** (points to the 'Group by' dropdown menu)
- Within the tree, errors can be sorted in various ways.** (points to the 'Severity' dropdown menu)
- Display and filter on the stars and checks marked by other users.** (points to the 'User' dropdown menu)
- Click on an error in the Error Browser to display documentation and bring up the error location in the main browser window.** (points to an error entry in the list)
- Shared stars and checks from other users are shown.** (points to a star icon next to an error entry)
- Click on Error Marker triangle to display information about this error in the Error Browser.** (points to a triangle icon next to an error entry)

The interface includes a tree view on the left, a list of errors in the center, and a detailed error description at the bottom. The error description for 'Error: Adapt block adapts previous block [118]' is visible, providing context and potential solutions.

2.7.2 Opening the Error Browser



You can open the Error Browser from the Hyperview window in three ways:

- Click the **Error Browser** button  in the toolbar.
- Press **E** on your keyboard.
- Click **View | Error Browser** in the main menu.

The Error Browser will be displayed showing the errors that were detected the last time the project file was built. Click on the **+** next to any of the branches to expand it and show the individual errors inside. Clicking on an individual error will cause the full error message along with brief documentation to appear in the panel below the error tree. Most errors contain hyperlinks (in blue). Click on these to display the associated locations in the main browser.

2.7.3 Marking errors as Starred, Reviewed or Hidden

In order to help manage errors in the Error Browser, you can mark them in one of three ways:

-  **Star** – use to indicate that an error requires attention.
-  **Review** – use to indicate that an error has been looked at and evaluated.
-  **Hide** – use to indicate that an error does not need to be further examined and can be hidden from view.

Using the **Show these errors** option on the left, you can filter what errors are shown in the tree based on how you marked them. For example, you can show only errors that are "not reviewed." The error marks are persistent, and will reappear when you next run Hyperview, and also when you view a new version of the project file in Hyperview.

2.7.3.1 Marking individual errors

You can toggle whether an individual error is marked as "starred," "reviewed," or "hidden" by clicking on the small icons to the left of every error item in the tree.

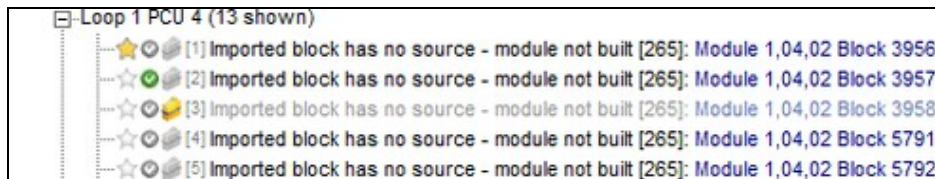

2.7.3.2 Marking selected errors

You can also select an error, and use the toolbar icons to mark it.

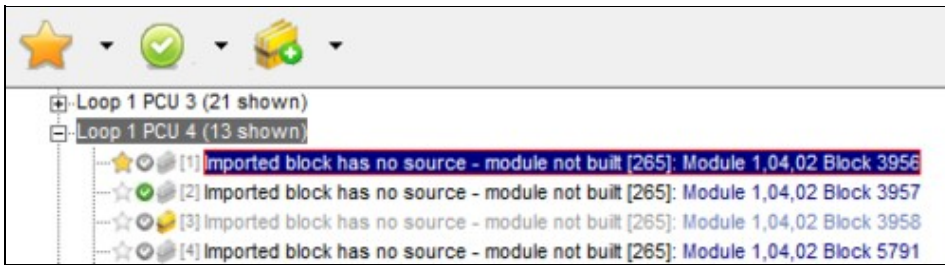

If you click on a "branch" item in the error tree, all of the errors in that branch will be selected. You can then use the toolbar to mark all of those errors at once. **Shift+Click** can be used to select a range of errors, and **Ctrl+Click** can be used to select multiple non-adjacent errors.

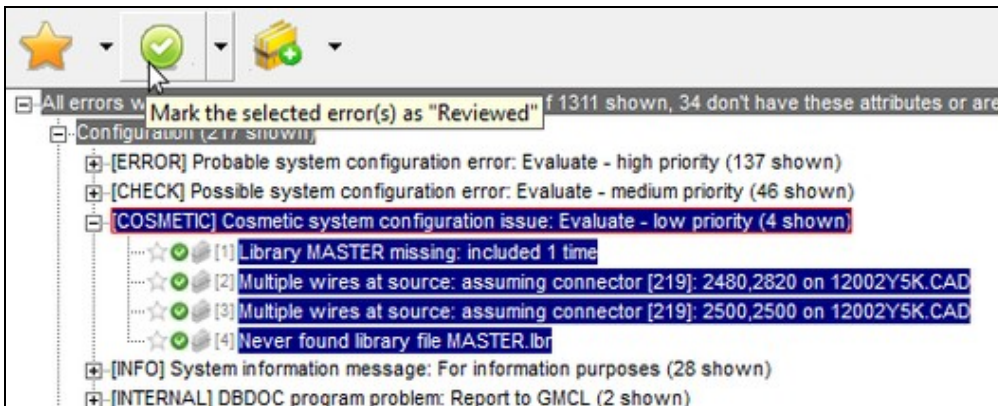

2.7.4 Filtering errors

All the errors that were detected during the last DBDOC build are built into the project file and can be displayed in the error browser. Because large number of errors are common in systems that have not yet been "cleaned up," it is important to be able to filter them in various ways.

The **Show these errors** drop-down menu to the left of the error tree allows you to display only errors that have been marked in certain ways. For example, choosing "Hidden" (and then pressing **Rebuild**) will cause only the errors that have been marked as "hidden" to be shown in the error tree. "Active" will show the non-hidden errors. Similarly, starred, reviewed, and not reviewed errors can be specifically displayed. You can always see every error by selecting "All" as this option.

As you become familiar with the errors in your build, you will invariably discover categories of potential errors that are not "real" errors in your system because some context explains their existence and they are known to not be harmful. Errors with "CHECK" severity will tend to fall into this category. Since those errors are not "real," they may never be corrected at the source (in your actual configuration) but you can nevertheless still mark them as "hidden" so that they do not clutter up the Error Browser error display.

2.7.5 Grouping errors

The error tree can be organized in a wide variety of ways based on the attributes of the individual errors. Most errors are associated with particular locations in the project, and can be grouped by file. Errors can be associated with particular subsystems, such as graphics, configuration, or database, and can be grouped accordingly. Many errors refer to particular blocks, and can be organized by Loop, PCU, and Module. Errors can be classified according to their severity. Some errors are serious and should be corrected. Others are cosmetic, and could be tidied up, but can also just be hidden if you don't want to deal with them. If you have worked with DBDOC's previous text file error support (.ERR files) you may find it convenient to group errors

according to what error file they appear in.

Because entire branches of the tree can be selected with a single click, and then marked with another, the ability to group errors provides a powerful way to understand and manage your errors.

2.7.6 New errors

Every time your project file is rebuilt, the errors generated during the build are built into the project file for viewing in the error browser. When you open the error browser, information about the errors is stored in a local database by Hyperview. This allows Hyperview to detect "new" errors (i.e. errors that have newly appeared in the new version of the project file you are looking at). These "new" errors are highlighted in the error browser to draw them to your attention.

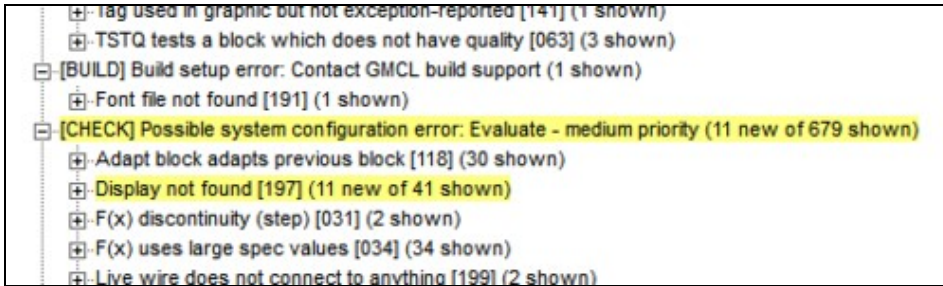

2.7.7 Sharing error information with other users

If you register for data sharing, other Hyperview users will be able to see which errors you have checked or starred, and you will be able to see which errors they have marked.

This is a powerful capability that makes it easy for a group to collaboratively assess and review errors. You could, for example, filter to show only the errors that had been reviewed by another user, select them with a single click, and then hide them all in your Error Browser. Or you could selectively display only the errors starred by another user, select them, and then mark them as "reviewed."

You can register to share data using the **Sharing** tab of the **Properties** dialog, accessible from the **Options** menu in the main Hyperview browser. Once you are registered, your error information will be automatically shared, and you will see the information of other sharing users.

Once you have registered for sharing, other registered users using the same data sharing folder will show up in this checkbox list. Check the checkbox for a user to make their data show up in the tree. In the example below, stars and checks from Jane and John will be displayed to the right of the errors in the tree.

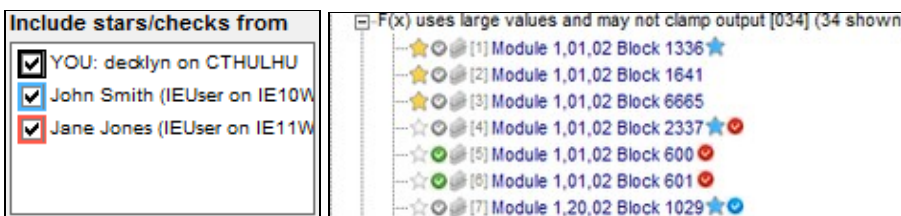

By selecting various combinations of **Show these errors** and **Include stars/checks from** options, you can easily display very specific categories of errors.

For example, this combination shows only the errors starred by John:

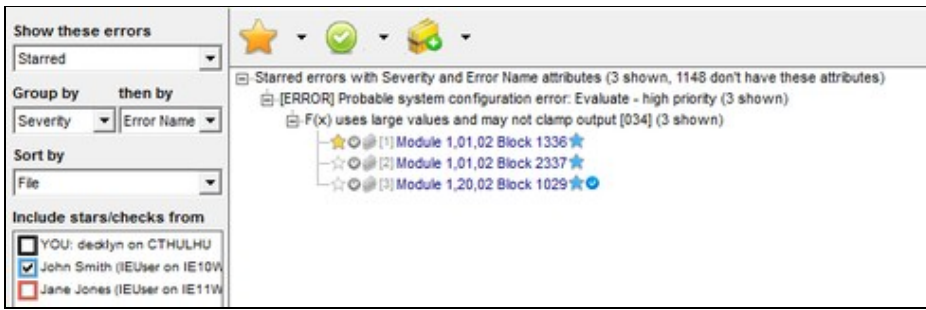

Hyperview automatically detects changes made to errors by other users. When such a change is detected,

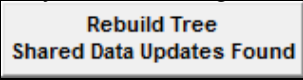
the **Rebuild** button  in the Error Browser activates. The detected changes will be included when the tree is rebuilt.

2.8 Customizing the Browser Display

2.8.1 Showing and hiding specs and attributes

2.8.1.1 Viewing specs on CAD/CLD diagrams

On a CAD/CLD sheet, block specifications can be hidden, or viewed in two different ways - either drawn directly on the sheet or drawn on a gray background.

To view specs:

- Press **S** on the keyboard
- **OR** Select **Specs** on the **View** menu and choose the view you want.
- **OR** Right-click on a CAD/CLD Sheet, select **Specs** in the **View** option of the popup menu and choose the view you want.

Note: The key **C** formerly was used for this purpose, until DBDOC 10.2.

Cycle through the different displays and turn off the specs by pressing **S** on the keyboard.

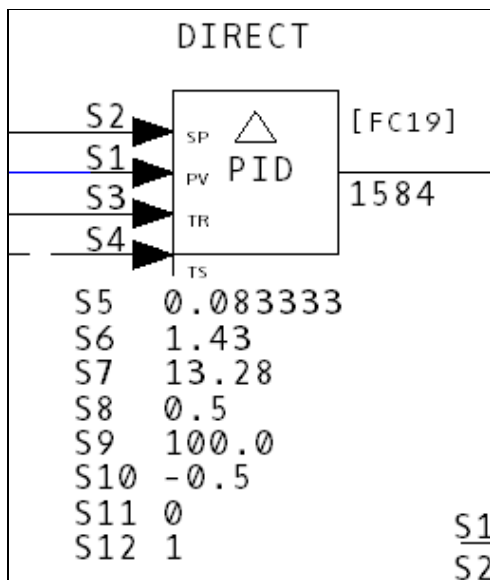

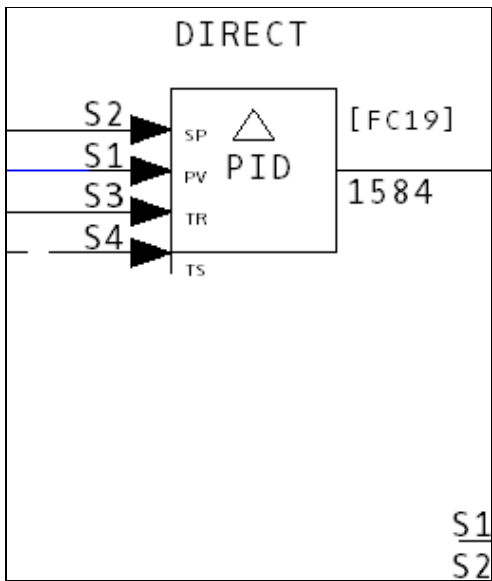
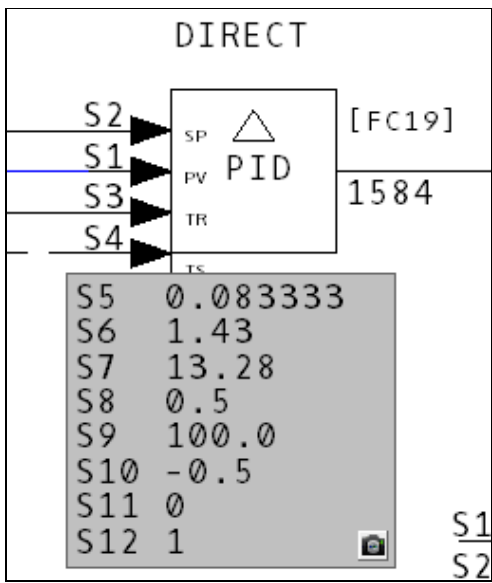

What if the specs are obscuring other information on your CAD/CLD sheet?

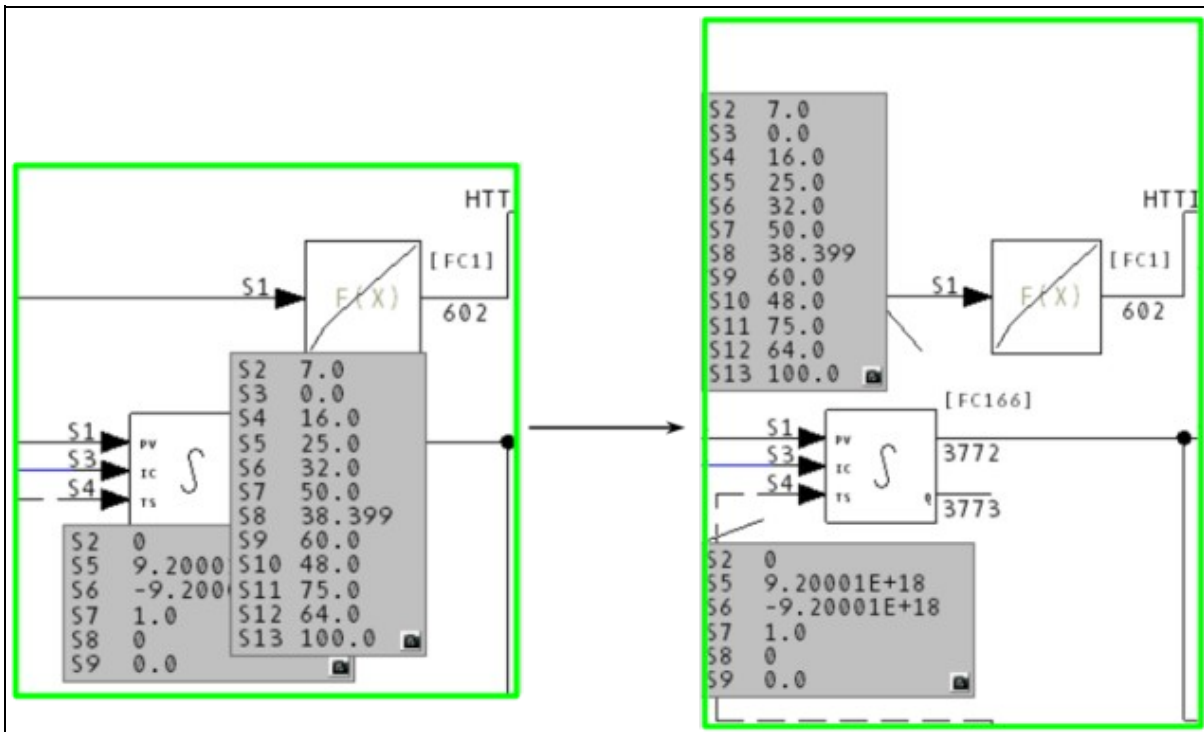

- In the **opaque** mode, click and drag the specs windows to different locations.

Some interesting features of the Specifications window:

- A "rubberband" links the spec window to its original position so that it is always clear which set of specs belongs to which block.
- Double-click on the spec window and it moves back to the original position at which it appeared.
- The locations of your specs are retained between Hyperview runs so once you have moved your spec windows to the locations that you like, they will stay there until you move them again.
- Live values for specs modified by Adapt Blocks is shown right next to the block they belong to.

2.8.1.2 Viewing attributes on CAD/CLD diagrams

On a CAD/CLD sheet, DBDOC displays the tag name and tag description above a tagged, exception-reported block. Like the specs, the attributes can be hidden, drawn directly on the sheet or drawn on a gray background. To view attributes:

- Press **A** on the keyboard
- **OR** Select **Attributes** on the **View** menu
- **OR** Right-click to bring up the popup menu and select **Attributes** from the **View** menu option.

Cycle through the different displays and turn off the attributes by pressing **A** on the keyboard.

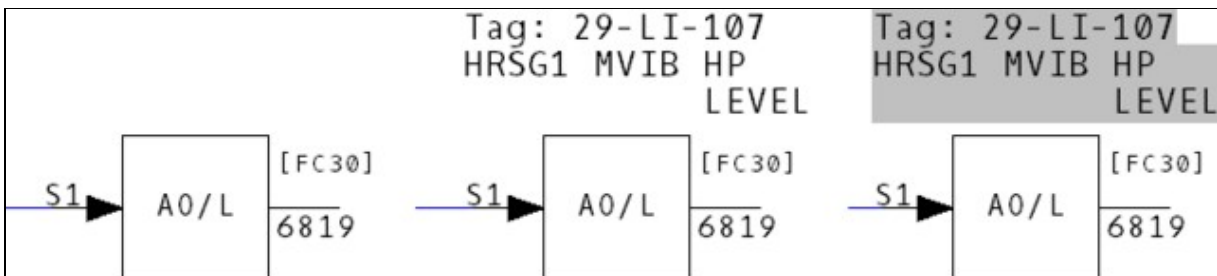

2.8.1.3 Showing live specs on CAD/CLD diagrams

New in DBDOC 11.1, live specs can now be displayed on top of static specs. These can be enabled by selecting **Enable Live Specs** in the **View** menu.

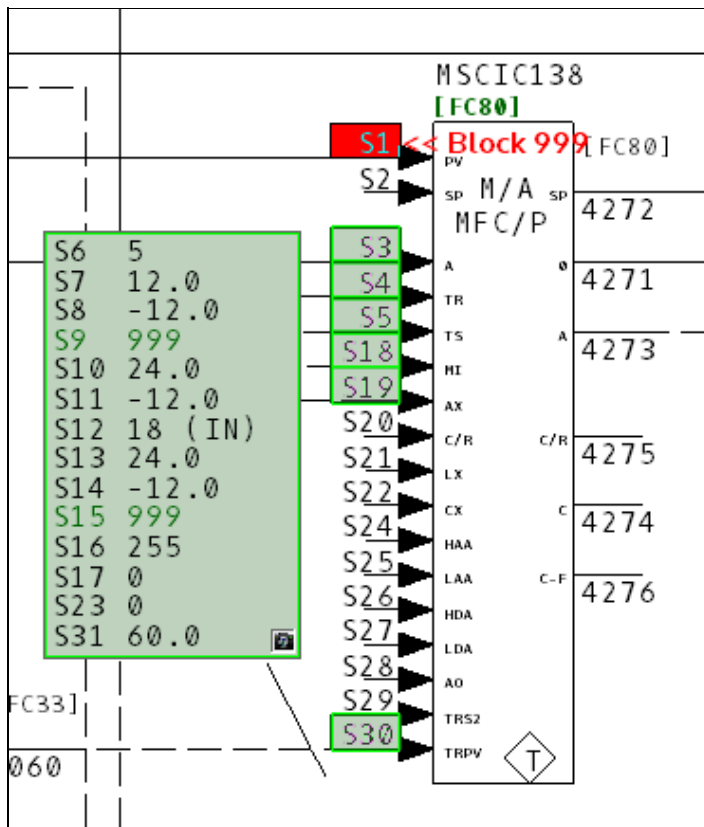

Live specs can then be turned on and off individually for each block by double clicking the camera in the bottom right corner.

2.8.2 Highlighting options in Hyperview

2.8.2.1 Highlighting search hits

Search Hits: With this option checked, search hits are highlighted on the document and you can scroll to the next or previous search hit. This may also be turned on via the popup menu that is brought up by a right-click. Select **Search Hits** from the **Highlight** sub-menu.

2.8.2.2 Highlighting hotspots

Hotspots: Highlights all the hyperlinks on a page. This is useful for determining the location of hyperlinks in a textual or graphical display. You can also use the **Ctrl+Tab** key combination to show all the hotspots on a page.

2.8.2.3 Showing "Vegas Lights"

Vegas Lights: With this option checked, a colorful marquee will appear to highlight your target. You can:

- Press **V** on your keyboard to toggle **Vegas Lights** on and off
- You can set the interval at which the lights blink on the **View** tab in **Options**

2.8.3 Options Menu: Properties for Hyperview

2.8.3.1 View options

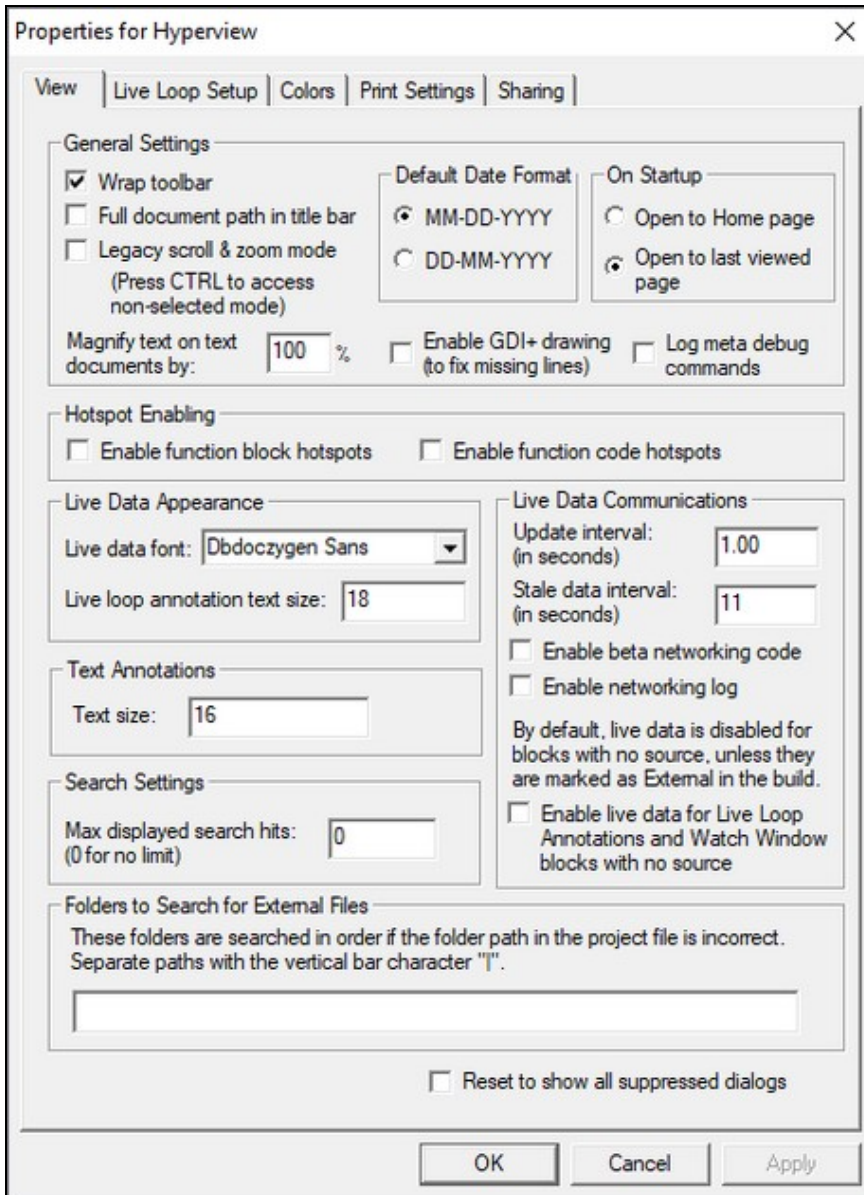

Properties for Hyperview

View | Live Loop Setup | Colors | Print Settings | Sharing

General Settings

- Wrap toolbar
- Full document path in title bar
- Legacy scroll & zoom mode
(Press CTRL to access non-selected mode)
- Magnify text on text documents by: %
- Enable GDI+ drawing (to fix missing lines)
- Log meta debug commands

Default Date Format

- MM-DD-YYYY
- DD-MM-YYYY

On Startup

- Open to Home page
- Open to last viewed page

Hotspot Enabling

- Enable function block hotspots
- Enable function code hotspots

Live Data Appearance

- Live data font:
- Live loop annotation text size:

Text Annotations

- Text size:

Search Settings

- Max displayed search hits: (0 for no limit)

Live Data Communications

- Update interval: (in seconds)
- Stale data interval: (in seconds)
- Enable beta networking code
- Enable networking log
- By default, live data is disabled for blocks with no source, unless they are marked as External in the build.
- Enable live data for Live Loop Annotations and Watch Window blocks with no source

Folders to Search for External Files

These folders are searched in order if the folder path in the project file is incorrect. Separate paths with the vertical bar character "|".

Reset to show all suppressed dialogs

OK Cancel Apply

An overview of the features available on the **View** tab of the **Options** window:

- **General Settings:**
 - ◆ **Wrap toolbar:** Controls whether the toolbar will wrap around instead of getting cut off if the Hyperview window is too small.
 - ◆ **Full document path in title bar:** If set, the title bar will display the entire path to the open project file.
 - ◆ **Legacy scroll & zoom mode:** Controls scrolling and zooming are inputted on graphics/CADs/etc. See the Guide to Basic Navigation in Hyperview for more information.
 - ◆ **Default Date Format:** Specify the date format you prefer to be used throughout Hyperview.
 - ◆ **On Startup:** If set to "Open to last viewed page," Hyperview saves the last document viewed before it closes so that when it is reopened, the project will be opened to that document. If set to "Open to Home page," the project will open to pages specified by the **Home** button.
 - ◆ **Magnify text on text documents:** Magnifies the all text documents in Hyperview by the set amount.
 - ◆ **Enable GDI+ drawing:** Under certain circumstances, CAD/CLD drawings can have "missing lines". This tends to happen on certain platforms when displayed on a remote desktop. Usually switching to the GDI+ graphics library solves this problem if you encounter it.
 - ◆ **Log meta debug commands:** Debugging feature.

- **Hotspot Enabling:** Specify whether you wish to enable Function Code and Function Block hotspots. These are not critical to regular signal tracing, and can be disabled for convenience.

- **Live Data Appearance:** Select the font and font size used to display live data.
- **Text Annotations:** Select the size of the font for the text that appears in your text annotations.
- **Search Settings:** Previously discussed in the Searching section.

- **Live Data Communications:**
 - ◆ **Update interval:** Set how often on-document live data is fetched in continuous mode.
 - ◆ **Stale data interval:** Set how long data is displayed as fresh before being displayed as stale.
 - ◆ **Enable beta networking code:** This causes Hyperview to use an alternate method of connecting to CIUMon. This improves responsiveness, but it still has a few issues that we are working on. If you'd like more information, please contact us.
 - ◆ **Enable networking log:** Debugging feature.
 - ◆ **Enable live data for Live Loop Annotations and Watch Window blocks with no source:** Attempt to fetch on-document data even for blocks that neither have a source in the configuration built into the project file, nor have been marked available in BuildPlus. Turning this on may cause problems, since data for such blocks may not actually be available.

- **Folders to Search for External Files** Specify additional folders to be searched for external files (files not built into the project file). See **Viewing external files** for more information.

- **Reset to show all suppressed dialogs:** Check this option to have the **No Search Results** and **Bookmark Message** dialogs appear the next time they are triggered.

2.8.3.2 Color options

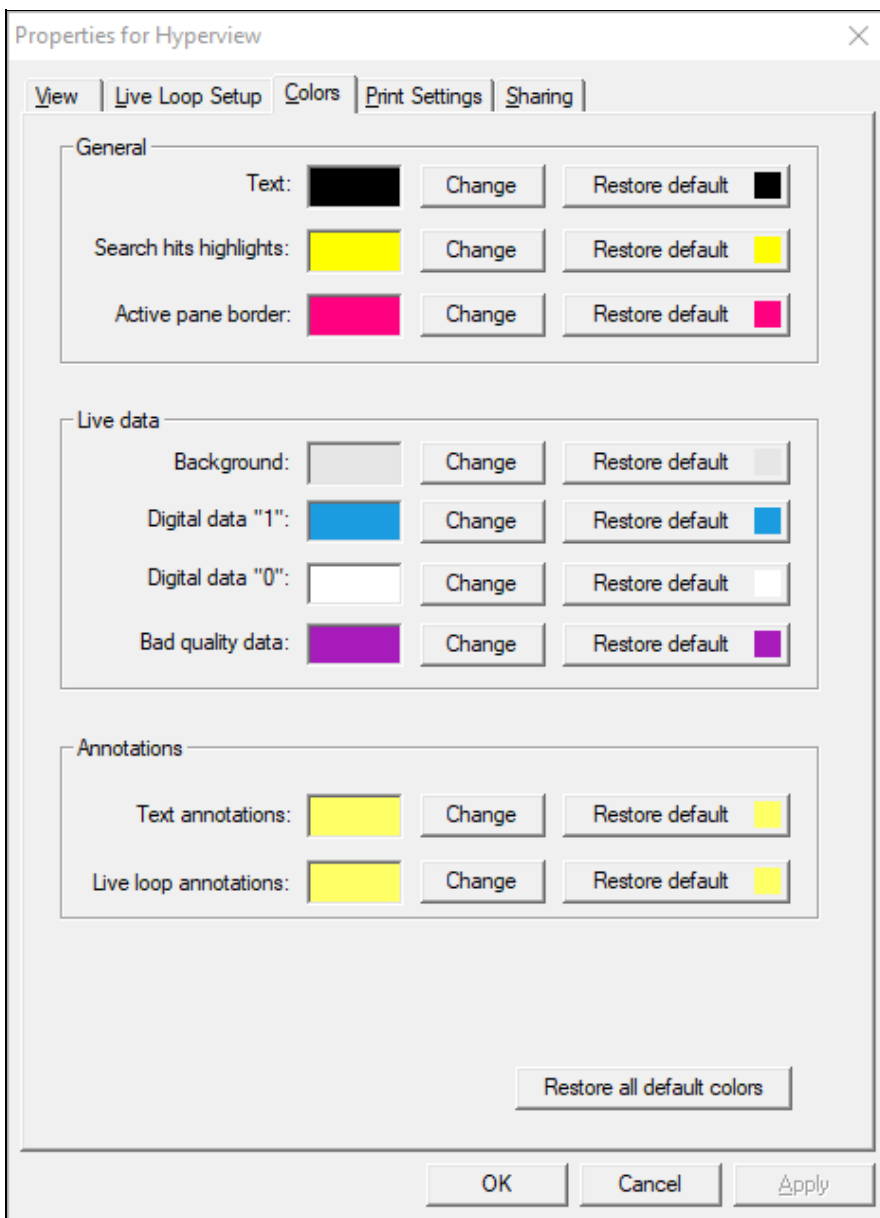

These options allow you to change the colors of various features within Hyperview. For example, you can change the colors for annotations.

Text Annotations:

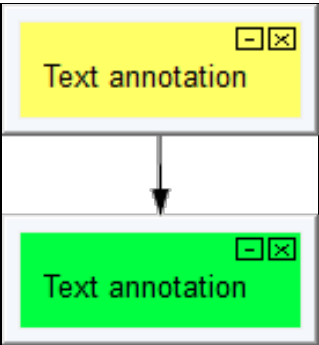

Live Loop Annotations:

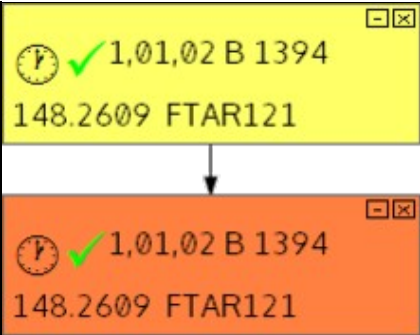

Restore default annotation colors with the **Reset colors to default** button.

2.9 Making Notes on Documents

2.9.1 Overview of Annotations

Annotations are like electronic sticky notes that you can attach to the majority of the documents contained within your project. There are two types of annotations that you can create:

1. **Text-based Annotations:** Make comments on a document to keep track of important things to note.
2. **Live Loop Annotations:** Create a note on a document that can fetch the live data value of any particular point in your system from anywhere in your project .

2.9.2 Text Annotations

Annotations are notes that can be created by two methods:

- Right-click on the document and select **Create Annotations** from the **Annotations** option on the popup menu.
- Click the **Create an Annotation** button  on the toolbar, and place the annotation on the desired document.

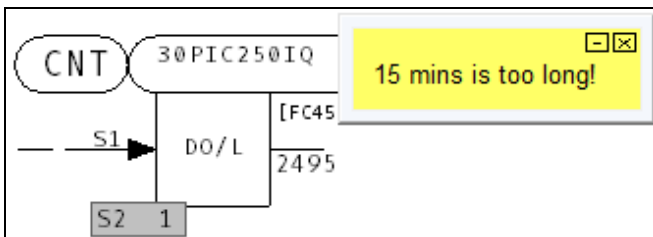
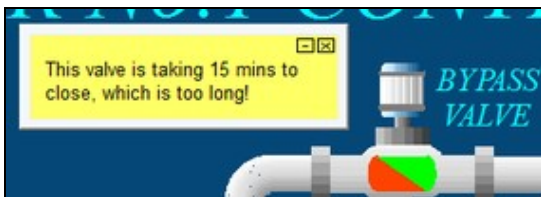

Text annotations can only be created on graphics and drawings, not on text files. Text annotations will persist across builds of your system. If you remove a topic, it will be listed as an *Invalid Topic* in the **Manage Annotations** dialog box. If you add a file back into your build it will activate the annotations that were originally on that document.

2.9.3 Managing Annotations

To move an annotation, drag and drop the annotation window or anchor point to the location you want.

If you have to make the same note in different places, you can make a copy of the original annotation and paste it anywhere you want. On the original annotation, right click and select **Copy Annotation** from the popup menu. Navigate to where you want to paste the annotation, right-click, and choose **Paste Annotation** from the **Annotations** menu.

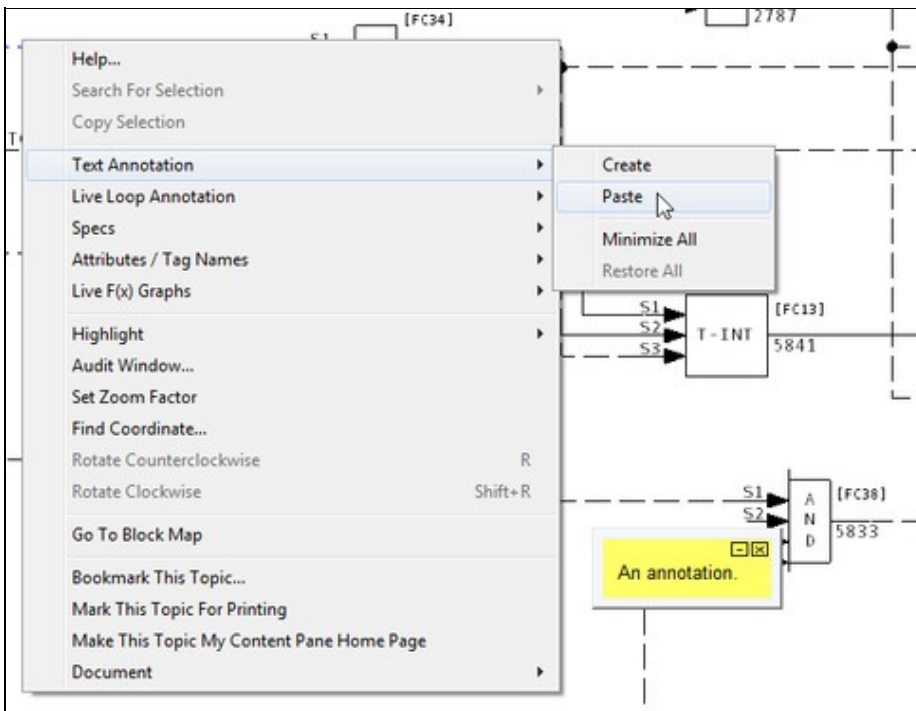

You can minimize or open all text annotations on a document by selecting the **Minimize All Annotations** or **Restore All** options respectively in the **Text Annotation** option on the popup menu.

- Minimized annotations will appear on the document represented by an anchor point.
- To open an individual annotation, click on the anchor point.
- Click the minimize button  in the upper right-hand corner to minimize an annotation.

You can view a complete listing of annotations by:

- Clicking the **Manage Annotations** button  on the toolbar
- **OR** selecting **Manage Annotations** under the **View** menu

This will bring up the **Manage Annotations** dialog box: Click on the **Annotations** tab.

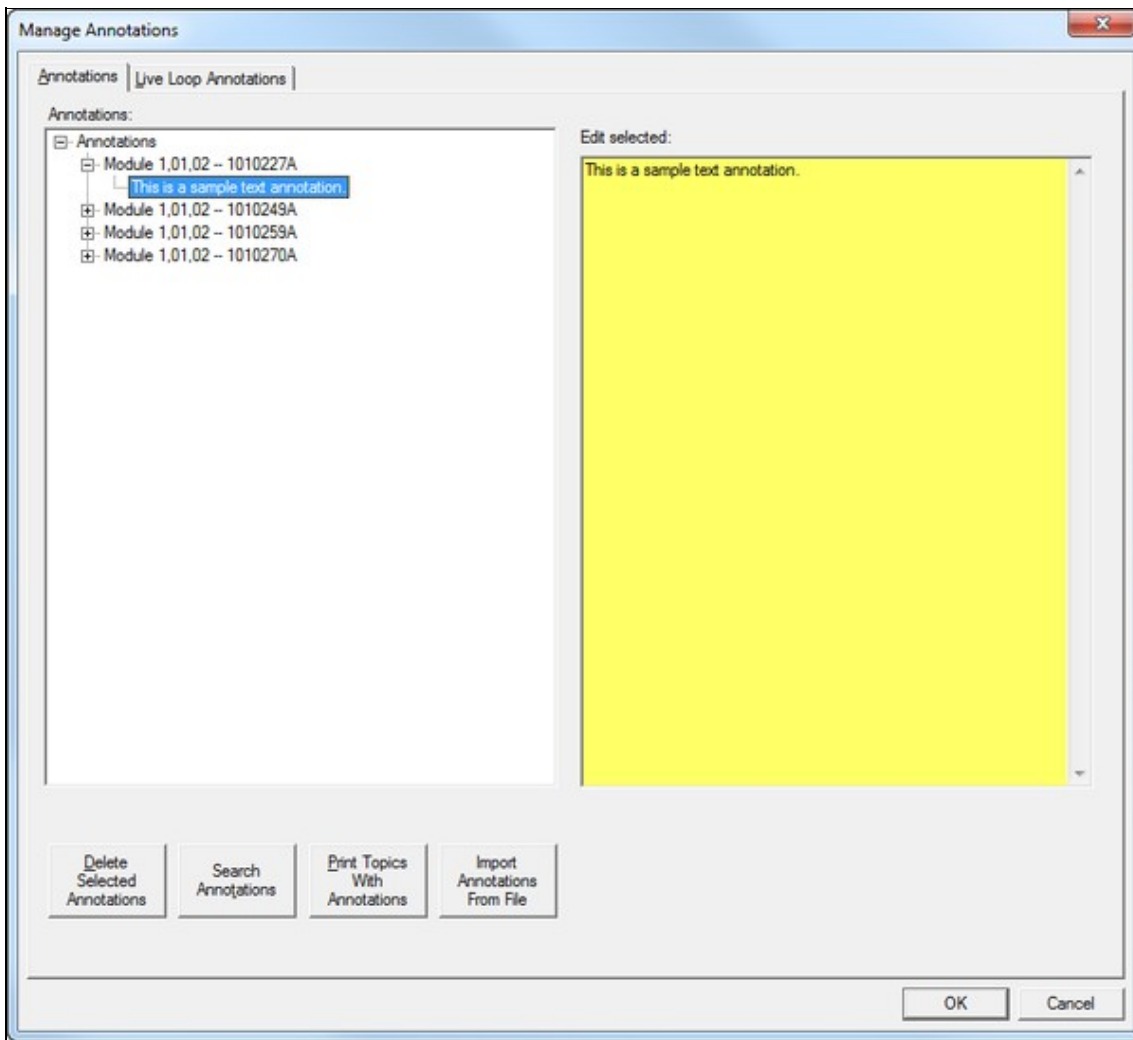

Clicking on either the topic or an annotation in the list will automatically take you to that document. You can edit text in the annotation by either:

- Changing the text in the original annotation window (double click on the window to open the editor or right click on it and select **Edit Annotation** from the popup menu)
- Edit the text in the right hand pane of the Annotations page in the **Manage Annotations** dialog. The changes will be reflected in the actual annotation window when the user makes a different selection in the document tree or the **Manage Annotations** dialog is closed by clicking the **OK** button.
- You can also delete individual annotations by right clicking on an open annotation and choosing **Delete Annotation** in the popup menu that appears or by clicking the  in the upper right-hand corner.

How to restore a deleted annotation:

1. Close the project file.
2. Edit the [project name].ann file.
3. Remove **Delete...** line
4. Modify **Visible** from 0 (zero) to 1. You do not have to change the associated hexadecimal value 0x00000000.

You can look for specific text in your annotations by clicking on the **Search Text** button in the **Manage Annotations** dialog.

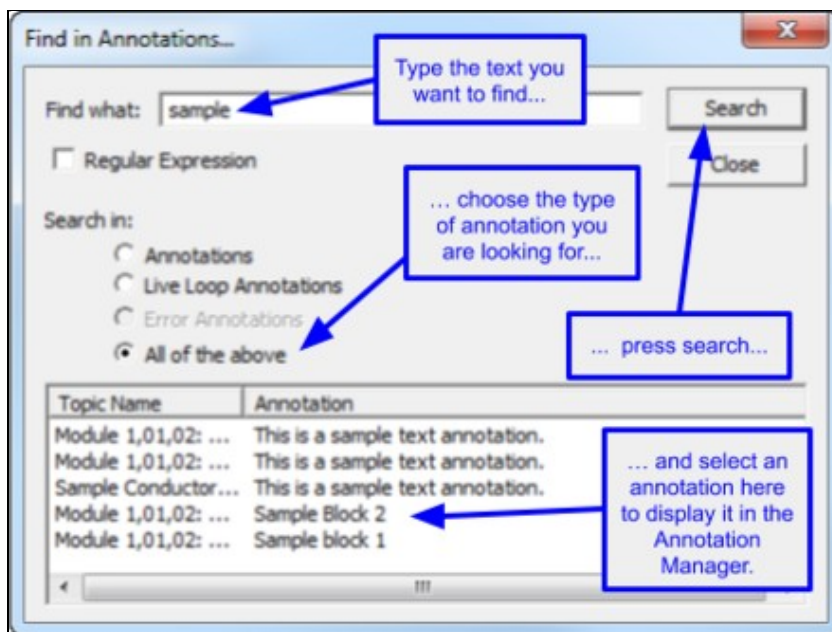

Type the text you are looking for in the **Find What** edit box, choose what you want to search in, and then click the **Search** button. Any annotations found to match your criteria will be shown in the list. Click on any item in that list to go directly to the document.

You have the ability to print your documents either with the annotations visible or suppressed. When they are suppressed, you won't even see the anchor point on the printout.

To suppress annotations while printing, uncheck the **Print Annotations** checkbox in the **Print** dialog or on the **Print Settings** tab under the **Options** menu.

To print annotations, select **Print Annotated Topics** from under the **File** menu, or click the **Print Annotated Topics** button in the **Manage Annotations** dialog.

The annotation source file is called [project name].ann. The annotation file is located in the following directories:

- **For Windows Vista/7/8 and later:** C:\Users\\AppData\Roaming\GMCL\DBDOC
- **For Windows 2000/XP/2003:** C:\Documents and Settings\\Application Data\GMCL\DBDOC
- **For Windows NT 4:** C:\WINNT\Profiles\\Application Data\GMCL\DBDOC

2.10 Printing Documents and Groups of Documents

2.10.1 Printing a single document

You can print the active pane by clicking the **Print** button  on the toolbar or by selecting from the various print options under the **File** menu. The pane that currently has focus will be printed.

If a dialog box appears asking you if you really want to print an index page, the answer is probably No. This is just a safeguard in case you have accidentally left the focus on the wrong pane. If you want the content (graphic or CAD/CLD sheet), make sure the focus is on the content (right/lower) side and print again.

Pages are printed with the drawing name, date and time and custom captions can be inserted. Our caption feature (in **Advanced Options**) lets you record a useful comment for this topic that will be printed at the bottom of the drawing.

Zooming in on a particular area gives you better resolution. A diagram will appear in the lower right hand corner of the print out, showing the portion of the drawing being printed.

2.10.1.1 Printing options

Various options can be set for printing:

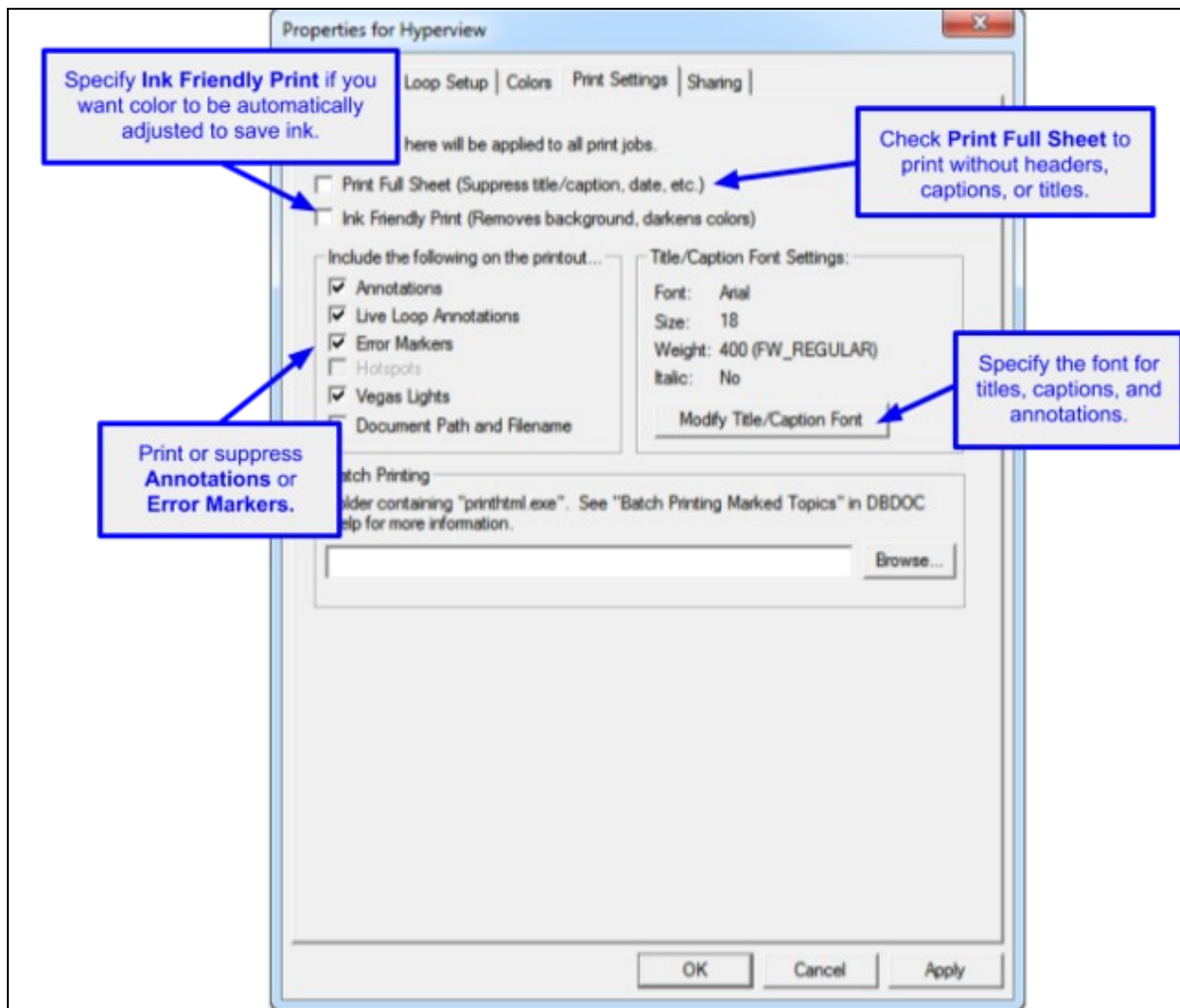

Any setting changes made here in the print dialog under the **Advanced Options** (e.g. **Suppress automatic color reversal**, **Annotations**, etc.) will be reflected in the **Print Settings** tab under **Options**.

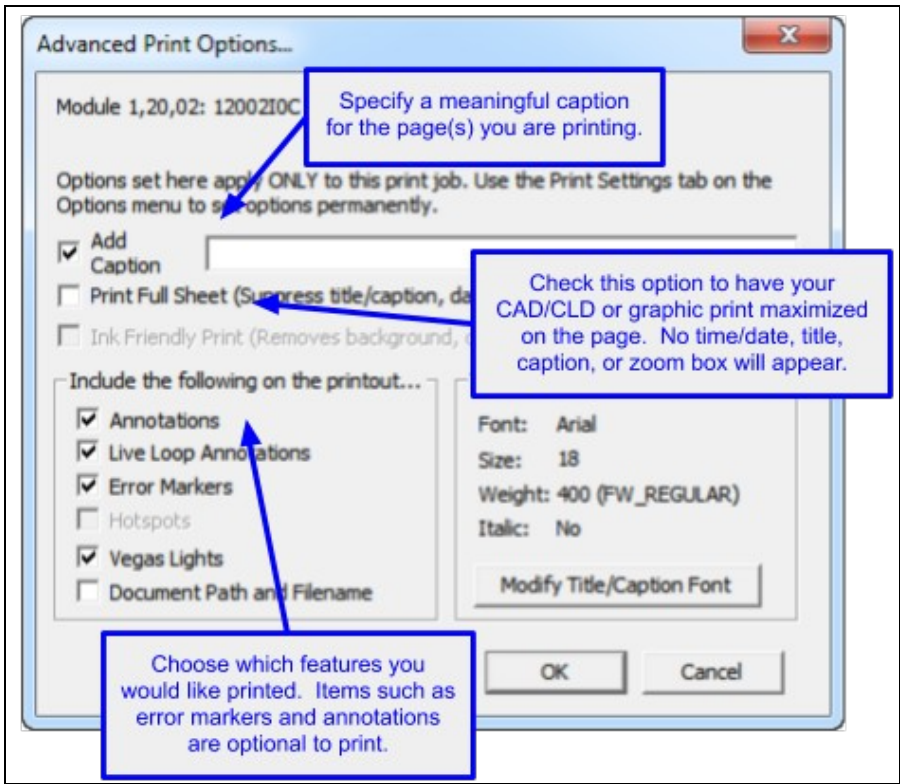
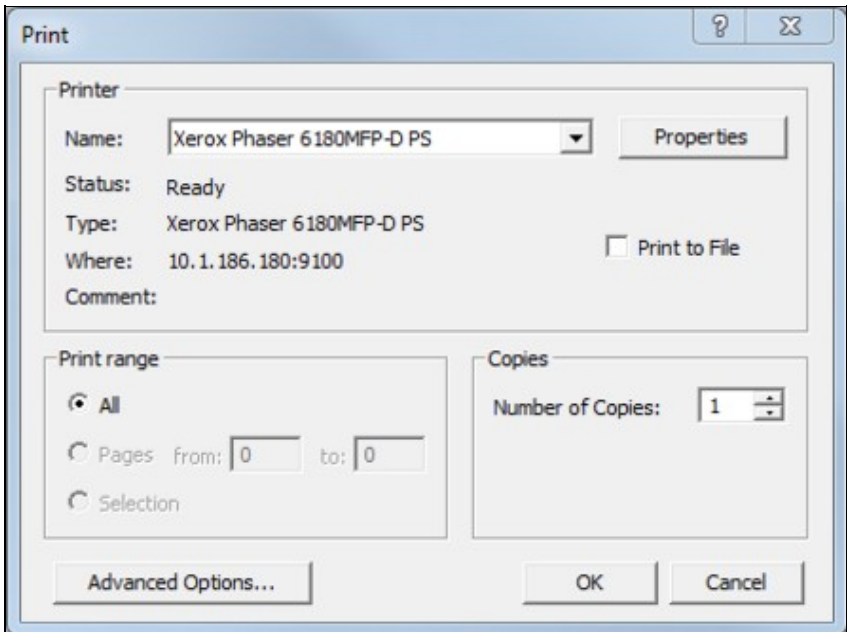

2.10.1.2 Fast Print to use your previously defined print settings

After doing the first print, you can avoid seeing the **Print** dialog box before each subsequent print by:

1. Selecting **Fast Print** from under the File menu.
2. Pressing **P** on the keyboard.

 **Note:** The print dialog box choices from the first print will be applied to subsequent prints.

2.10.1.3 Printing selected text

You can select a portion of any text document, including the contents of the index pane, to print. The **Selection** radio button in the print dialog box will be enabled.

2.10.2 Marking the current topic for later printing

This option is useful when a large number of topics needs to be printed at one time. You can use the easy popup menu interface to add a document. Right-click on the document and select the **Mark This Topic For Printing** option from the popup menu.

2.10.2.1 Marking the current topic for printing

When you choose **Mark This Topic For Printing** in a pop-up menu, the current topic will be marked for printing, and added to the **Marked Topics** list in the **Mark Topic for Printing** dialog.

2.10.2.2 Marking a linked topic for printing

If you choose **Mark "[document]" For Printing** in a hotspot pop-up menu for a hotspot in the index pane than links to a document (for example, a graphic), the linked topic will be added to the **Marked Topics** list.

On the **File** Menu, click **Mark Topic For Printing....** This displays the **Mark Topic for Printing** dialog.

2.10.3 Using the Mark for Print dialog to print groups of topics

The **Mark for Print** feature allows you to "mark" or select a topic or group of topics for printing. The marked topics are stored in the **Marked Topics** list shown in the **Mark Topic for Printing** dialog. Once topics are in the list, they can be printed en masse. This feature allows you to easily collect topics for printing as you are browsing, and also to print all (or some) topics of a certain type, for example CAD sheets, BATCH files, or topics with annotations, without having to view and select each topic individually.

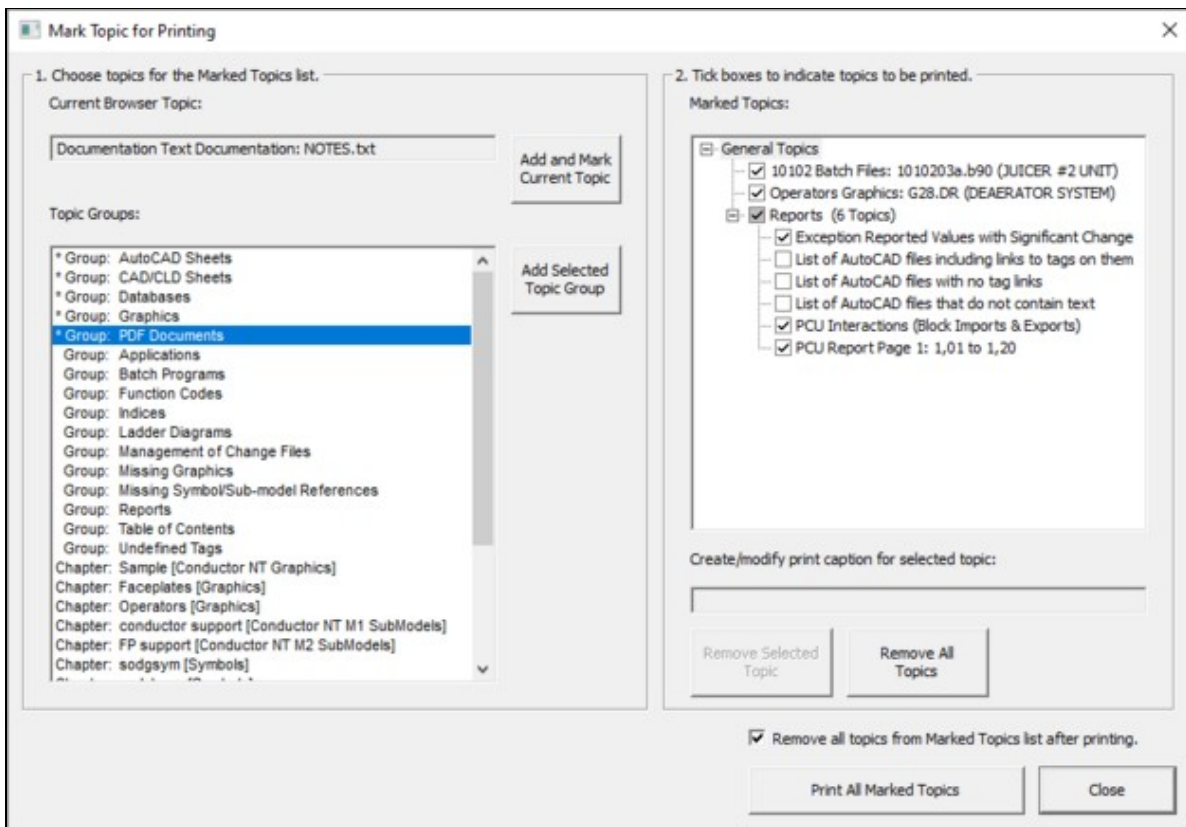

2.10.3.1 Marking a group of topics for printing

In the **Mark Topic for Printing** dialog,

1. Select **All Topics in Group** from the **Mark** Menu.
2. Select a group of topics from the **Groups** Menu.
3. Click **Add**
4. Make sure the the desired group has been added to the **Marked Topics** list box, and items to be printed are checked off. The topic groups in the **Marked Topics** list box are expandable, and individual items can be unchecked if you do not wish to print them.
5. If you wish to print the topics in the **Marked Topics** list now, click **Print Topics**.

2.10.3.2 Removing topics or groups of topics from the marked topics list

In the **Mark Topic for Printing** dialog,

1. Select the desired topic or group to remove by highlighting it in the **Marked Topics** list box.
2. Click **Delete** to remove the highlighted group or topic.

OR

1. Click **Delete All** to remove all items in the **Marked Topics** list box.

2.10.3.3 Other options

In the **Mark Topic for Printing** dialog,

- **Delete General Marked Topics List on Close Once Printed:** General topics shown in the **Marked Topics** list are cleared when the dialog box is closed if they have been printed.
- **Enter/modify caption for selected topic:** Allows you to create or change a caption for the selected topic. Use this option to include comments about the topic; the drawing title is printed automatically above the caption.
- **Save Topic To File:** Clicking this button will bring up the standard **Windows Browse** dialog which will allow you to specify a location in which to save the selected files in the **Marked Topic** list in text form. Once a directory has been selected, the files will be saved immediately.

2.11 Sharing Data with Other Hyperview Users

2.11.1 Overview of User Data Sharing

Choose **Options** in the main menu to open the **Properties for Hyperview** dialog. Click the **Sharing** tab to display the Hyperview data sharing settings.

Certain user data can be shared "live" among users. For example, the stars and checks with which one user marks errors in the Error Browser can be displayed in the another user's Error Browser, and bookmarks can be shared among multiple users. Sharing is not yet supported for all user data, but over time support will be increased. Eventually annotations, live loop annotations, and watch window groups will all be able to be shared easily among users.

When you run Hyperview, your personal user data files are stored in a hidden folder. When you enable data sharing, some of these hidden data files are copied to a central repository, the **Shared Data Folder** where they are available to other Hyperview users. The data in them can then be displayed in Hyperview browsers belonging to other people.

2.11.2 Specifying the Shared Data Folder

In order to share user data, a **Shared Data Folder** must be specified. This can be any folder on your network file system to which all the sharing users have read and write access. Usually the name of this folder will be built into the project file in BuildPlus, and you won't need to change it. But if it is not built in, you can specify it here.

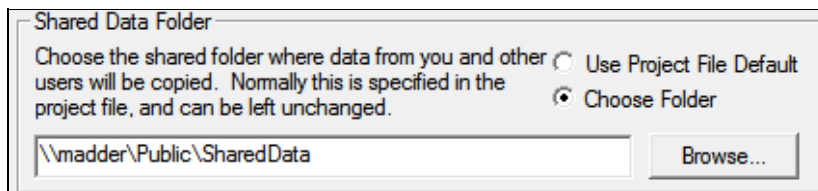

2.11.3 Updating your user information

You can specify or update your first and last name, and enter a note. Other users will see this information. If you leave these fields blank, other users will still be able to see your username and computer name.

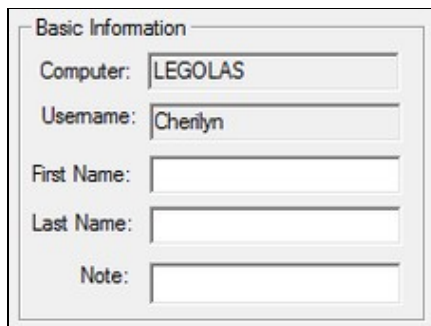

2.11.4 Specifying what sorts of user data to share with others

In this area, specify which data you want to share with other users. For example, if you don't want to let others see your error information, but still want to see theirs, just uncheck **Error Stars & Checks**.

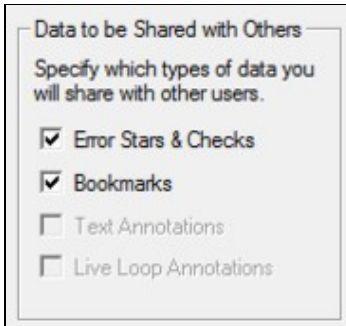

The screenshot shows a window titled "Data to be Shared with Others". Below the title is the instruction: "Specify which types of data you will share with other users." There are four checkboxes listed: "Error Stars & Checks" (checked), "Bookmarks" (checked), "Text Annotations" (unchecked), and "Live Loop Annotations" (unchecked).

2.11.4.1 Specifying whose data to include by default

You can specify the users whose data you wish to include by default (and override this default elsewhere if you need to).

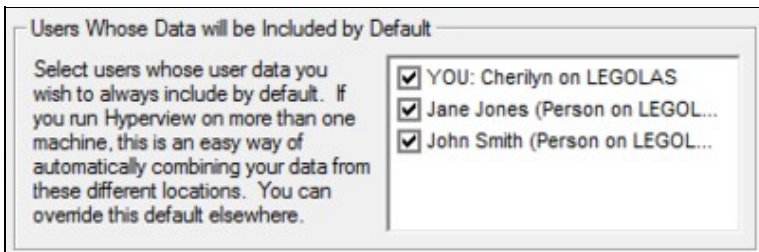

The screenshot shows a window titled "Users Whose Data will be Included by Default". Below the title is the instruction: "Select users whose user data you wish to always include by default. If you run Hyperview on more than one machine, this is an easy way of automatically combining your data from these different locations. You can override this default elsewhere." To the right of the instruction is a list of three users, each with a checked checkbox: "YOU: Cherilyn on LEGOLAS", "Jane Jones (Person on LEGOL...", and "John Smith (Person on LEGOL...".

2.12 Tools, Reports and Indexes

2.12.1 Viewing the resources used in a drawing with the Audit Window

You can use the Audit Window to view the resources used in a CAD/CLD or graphic. This includes:

- Block and tag usage
- Input and Output references
- Function blocks
- Graphics / document links

You can open the Audit Window by either selecting it from under the **View** menu, from the popup menu on a right mouse-click, or the  button on the toolbar.

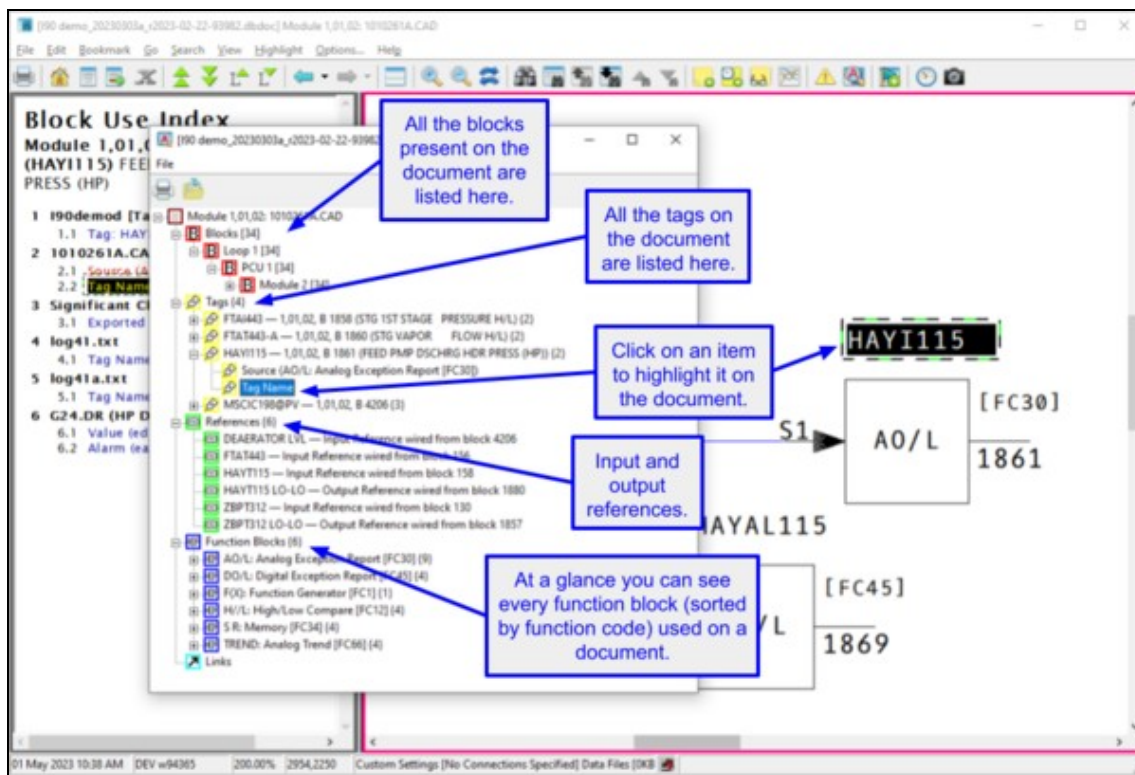

The screenshot displays the 'Block Use Index' window in a CAD/CLD software. The index lists various resources used in the document, including tags, function blocks, and references. The index is organized into sections: Tags (4), References (6), and Function Blocks (6). The 'Function Blocks' section is expanded, showing a list of function blocks sorted by function code, such as AD/L: Analog Exception Report (FC30), DO/L: Digital Exception Report (FC45), and FC: Function Generator (FC11).

Callouts provide additional information:

- All the blocks present on the document are listed here.
- All the tags on the document are listed here.
- Click on an item to highlight it on the document.
- Input and output references.
- At a glance you can see every function block (sorted by function code) used on a document.

The diagram in the background shows a function block labeled 'AYAL115' with input and output references. The input reference is 'S1' and the output reference is '1861'. The function block is also labeled 'HAY115' and 'A0/L'. The diagram also shows a function block labeled 'AYAL115' with input and output references. The input reference is 'S1' and the output reference is '1861'. The function block is also labeled 'HAY115' and 'A0/L'. The diagram also shows a function block labeled 'AYAL115' with input and output references. The input reference is 'S1' and the output reference is '1861'. The function block is also labeled 'HAY115' and 'A0/L'.

Hyperview will highlight the selected target from the Audit Window and zoom in to the appropriate level. You can save the Audit Window contents for printing or editing later.

- Select **File** then **Export**
- Or print them now with **File** then **Print**
- You can print or export the whole list or just the individual parts of the list, i.e. the Blocks, Tags, References, or Function Codes. There are also various formats in which the list can be printed or saved, allowing you to get the information in a format that best suits your needs. A default name will also be supplied.

Below is a drop-down menu for Audit Window/File/Export:

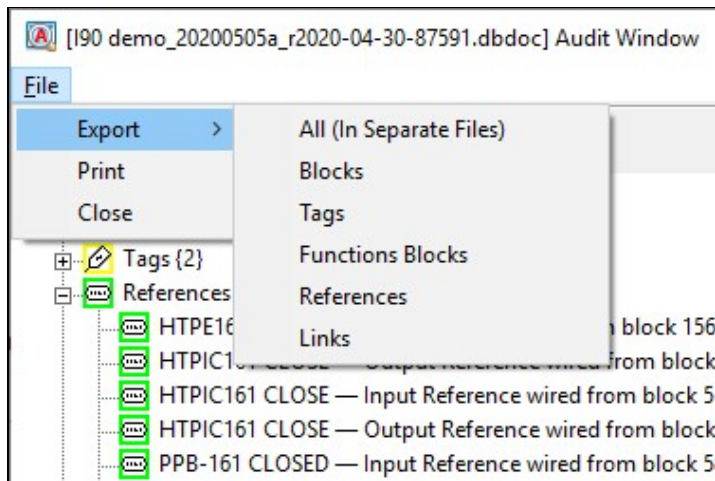

Why do you want to use Audit Window?

- Checklist for tags
- All places a block is used on the CAD/CLD or graphic
- Verify that a block is used consistently
- See the tags on an AutoCAD or MicroStation sheet
- On graphics, determine if the uses of a tag are spread across the page

2.12.2 Using PCU Map to understand interactions among PCUs

The PCU Map shows you the interaction between PCUs, listing what blocks are exported and imported between two units. Access the PCU Map from the **System Information** chapter by clicking on the PCUMap.txt entry. Click on the **PCU Report Page** link to bring up a table similar to the following:

PCU Report Page 1: 1,00 to 3,05

How to read this report:

The PCU on the left is read first, then "E" or "I", then the PCU on the top.

"E" means "PCU left exports to PCU top."

"I" means "PCU left imports from PCU top."

The number preceding "E" or "I" is the export or import count.

	1,00	2,01	2,02	2,05	3,01	3,02	3,03	3,04	3,05
1,00									
2,01			2I 4E		5I 9E	1I			
2,02		4I 2E		62I 22E	3I 1E	1I		1I	
2,05			23I 57E						
3,01		10I 5E	1I 3E			5I 6E	1I 3E	2I 11E	10I 7E
3,02		1E	1E		6I 5E		2I 6E	2E	2E
3,03					3I 1E	6I 2E		1I 4E	2I 1E
3,04			1E		11I 2E	2I	4I 1E		10I 5E
3,05					7I 10E	2I	1I 2E	5I 10E	
3,06					1I 4E	8I 6E			
3,10					1I		1I 5E	13I 6E	15I 12E
5,01					1I				
5,02		1E				1E			
5,03		9I 7E							
5,04			2E						
5,05		3E	2I		1I 2E	1I			
5,07									
5,08			2E						
5,09			2E						
6,50							1I	2I	1I
6,51		9I			4I	2I	1I	1I	1I
7,01									
7,02									
7,05		15I 12E			13I 10E	11I 2E		1I	
7,07		4I 1E			1I	2I			
7,08					1I				

Click on a link in the table to bring up the specific block interaction between two chosen PCUs.

Interactions between PCU 2,02 and PCU 2,01

PCU 2,02 exports to PCU 2,01

- Exported Point** [Module 2,02,20 Block 9565](#)
Imported by [Module 2,01,10 Block 4286](#)
- Exported Point** [Module 2,02,20 Block 9567](#)
Imported by [Module 2,01,10 Block 4285](#)

PCU 2,02 imports from PCU 2,01

- [Module 2,02,20 Block 5419](#) gets value from [Module 2,01,20 Block 127](#)
- [Module 2,02,20 Block 951](#) gets value from [Module 2,01,20 Block 177](#)
- [Module 2,02,10 Block 5519](#) gets value from [Module 2,01,20 Block 36](#)
- [Module 2,02,20 Block 9542](#) gets value from [Module 2,01,10 Block 4298](#)

2.12.3 Graphical Block Map: a graphical overview of block usage

Block map is a graphical overview of block usage, showing configuration aspects and issues at a glance.

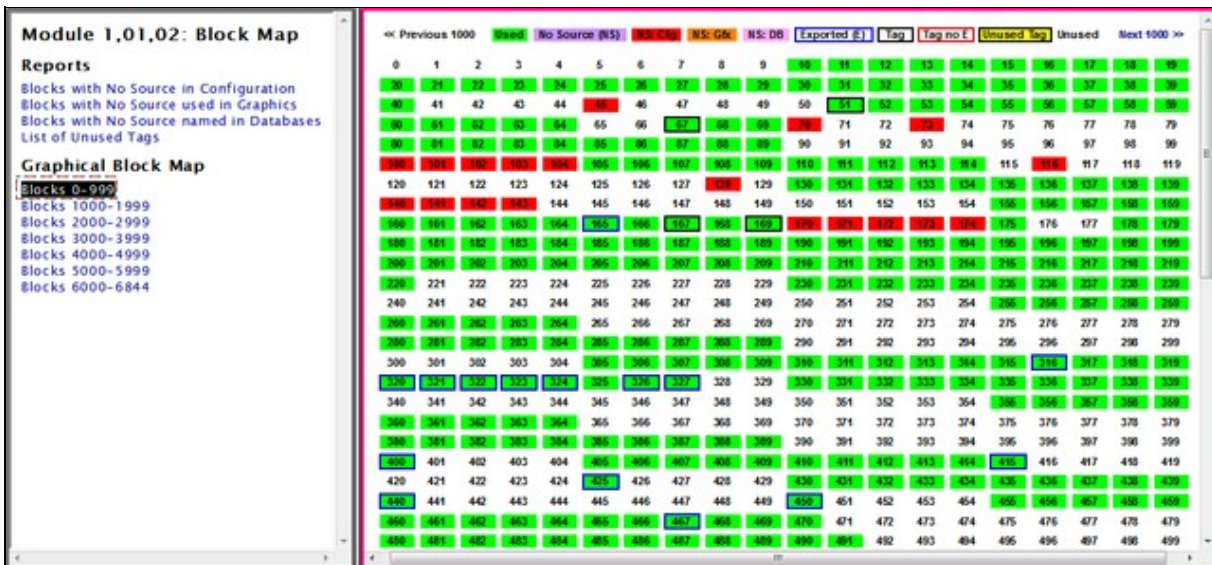

The Block Map can be accessed by either:

- Clicking on the **Block Map** link available at the beginning of each chapter of CAD/CLD sheets.
- Right-clicking on a CAD/CLD Sheet and selecting **Go to Block Map** from the popup menu that appears.
 - ◆ If you right-click on a specific block, the corresponding module block map page will be brought up in the content pane and the Table of Contents will display the **Block Map Index** for the module. The selected block and appropriate block range will be highlighted by Vegas Lights (if that option is turned on under the **Highlights** menu).
 - ◆ If you right-click while on white space on the CAD/CLD Sheet, only the Table of Contents will be updated to bring up the **Block Map Index** for that particular module.

Explanation of the Block Map color legend:

Used = (Green block) This block is used.

NS: Cfg = (Red Block) This block is used in configuration but the source does not exist (or is not built.)

NS: Gfx = (Orange Block) The block is used on a graphic, but not sourced in configuration.

NS: DB = (Pink Block) This block is referenced in a database, but not sourced in configuration.

No Source (NS) = (Purple Block) This block does not have a source, but is sourced somewhere in the system.

Exported (E) = (Blue Border) The block is exported, but not tagged.

Tag = (Black border) The block is tagged and exported.

Unused Tag = (Yellow block) The block is tagged, but unused.

Unused = (White block and border) The block is completely unused.

Ideally, what you want to see for your blocks is: **1041**

A green block with a black border is a "perfect tag" - tagged, exported and used. The Block Map allows you to see where blocks are available for insertion of a large function code.

2.12.4 Tag Index: an alphabetical index of all the tags in your system

The **Tag Index** is an overall view of all the tags in all your databases.

Tag Index		Tags beginning with F		
		Tagname	Tag Description	
Tags beginning with 0		F13050	TOTAL AIR FLOW STAGE I	190demod 1,03,03 B 1718
Tags beginning with 2		FIC3000	BLOWER AERN FLOW SP & PV ADD	1,03,03 B 8816
Tags beginning with 3		FIC3001	PRE-AERATION 1&2 AIR FLOW	1,03,03 B 6210
Tags beginning with 4		FIC3002	PRE-AERATION 3&4 AIR FLOW	1,03,03 B 6310
Tags beginning with 8		FIC3003	AERATION CHANNEL AIR FLOW	1,03,03 B 6410
Tags beginning with A		FIC3004	GRIT & INLET CH. AIR FLOW	1,03,03 B 6710
Tags beginning with B		FORC000	VAP TB GOVERNOR VLV POSITION	1,01,02 B 2105
Tags beginning with C		FT10016	SLUDGE GAS FLOW	2,10,03 B 6160
Tags beginning with D		FTAAH115	VAP TURBINE INLET PRESS HI	1,01,02 B 2137
Tags beginning with E		FTAAH121	HP VAP TURB INLET PRESS HI	1,01,02 B 1433
Tags beginning with F		FTAAH349	PROCESS VAPOR PRESS HI	1,01,02 B 1531
Tags beginning with G		FTAAHH121	HP VAP TURB INLT PRESS HI HI	1,01,02 B 1432
Tags beginning with H		FTA1115	HP VAPOR HEADER PRESSURE H/L	1,01,02 B 1455
Tags beginning with I		FTA1121	STG 101 INLET PRESS	1,01,02 B 1393
Tags beginning with K		FTA1175	HRSG101 IP VAP HDR PRESS	1,01,02 B 2206
Tags beginning with L		FTA1181	IP VAPOR HDR PRESS H/L	1,01,02 B 1391
Tags beginning with M		FTA1349	PROCESS VAPOR PRESSURE H/L	1,01,02 B 1534
Tags beginning with N				

The **Tag Index** is found in the **Database** chapter in the Table of Contents. It is comprised of an alphabetical and numerical listing of all the tags in your system. Each tag database is a column and each tag is a row. If a tag is present in a database, it will appear in the appropriate column, with its associated Loop, PCU, Module and Block information. The LPMB information is a link that you can click on that will take you to the corresponding Block Index page. If the tag is not present in a database, the text **ABSENT** will appear in the column.

Tips for using the Tag Index:

- For quick loading, switch to **Treeview Table of Contents** mode (press **Ctrl+ T**).
- When you click on a Block Index link, it will highlight the first reference to that block, not the one that you clicked on.
- The database column headers are not repeated but the databases are in the same order as in the Table of Contents (alphabetic).

2.12.4.1 Using the Tag Index

To find inconsistent LPMB in your tags:

- Do a Full Text Search in current topic for Exact Match for ++.
- Inconsistent tags appear in red and are preceded by the text ++.
- In `DBDOC_TAG_MISMATCH.ERR`, look for the **Tag mismatch for X: see TAGMAP for details**.

To get a list of all tags in your system:

- Select and print the individual **Tag Index** pages.
- If you have more than four databases, set your printer to use landscape orientation.

To walk through the Tag Index pages:

- Click on the first letter combination and page down to see all the tags in that section.
- Type **B** for browse to see each section.

 **Note:** You can also locate these graphics and symbols by looking at the **Undefined Tags**, **Missing Graphics**, and **Missing Symbols or Submodels** lists located in the **System Information** chapter of the project.

- For quick loading, switch to **Tree View Table of Contents** mode (**Ctrl+T** keys).
- When you click on a Block Index link, it will highlight the first reference to that block, not the one that you clicked on.
- The database column headers are not repeated but the databases are in the same order as in the Table of Contents (alphabetic).

Find inconsistent LPMB in your tags:

- Do a **Full Text Search** in current topic for Exact Match for ++.
- Inconsistent tags appear in red and are preceded by the text ++.
- In `DBDOC_TAG_MISMATCH.ERR`, look for the **Tag mismatch for X: see TAGMAP for details**.

Get a list of all tags in your system:

- Select and print the individual **Tag Index** pages.
- If you have more than four databases, set your printer to use landscape orientation.
- Walking through the **Tag Index**:
- Click on the first letter combination and page down to see all the tags in that section.
- Type **B** for browse to see each section.
- For quick loading, switch to **Tree View Table of Contents** mode (**Ctrl+T** keys).
- When you click on a Block Index link, it will highlight the first reference to that block, not the one that you clicked on.
- The database column headers are not repeated but the databases are in the same order as in the Table of Contents (alphabetic).

2.12.5 Graphics Cross-Reference Window: index of all the graphics that link to and from the graphic, plus included symbols

The **Display Cross-References** option displays an index of all the graphics that link to and from the graphic as well as symbols included in the graphic. This tool also shows symbols individually and any graphics that include the symbol. The **Cross Reference Index** page for a particular graphic provides information similar to the Audit Window except across the whole DBDOC system. When building your project, in the **BuildPlus Project Options**, choose the **Advanced Options** on the **Processing Options** page and make sure the **Exclude Symbols and Submodels** chapters from build is unchecked to get full symbol cross references.

Accessing the Cross Reference Window while on a graphic:

- Click the **Display Cross References** button 
- Under the **Go** menu select **Display Cross References**
- Type **X** on your keyboard

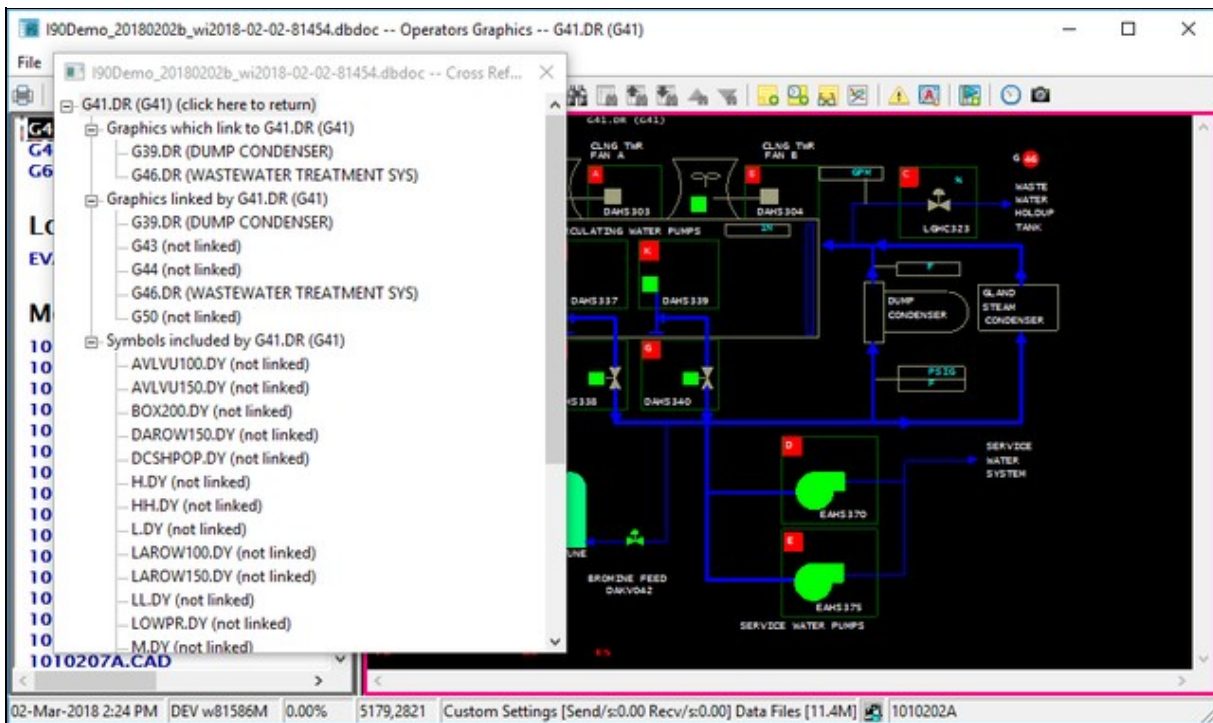

A separate floating window will be opened showing you the different Graphics Cross References categories, handily displayed in a tree view:

The position and size of the **Cross Reference Window** will be retained between runs so that you do not need to reset them to suit your preferences each time the feature is used. The window will remain open while you navigate to different documents in your project file until you choose to close it or open up a different project file.

You can always return to the original graphic referenced in the **Cross Reference Window** if you have moved onto different documents by clicking on the "(click here to return)" link at the top of the tree.

This feature can be used to cross-check a number of things in your system:

- Find out which user symbols are no longer used by your graphics
- Step through your symbol chapters
- Bring up the cross-references for each symbol
- Symbols that are never used will have a blank cross-reference page
- Locate graphics not being built but are still being linked to
- Step through your graphics chapters
- Bring up the cross-references for each graphic
- Black entries (no hotspot) in the **Cross Reference Index** indicate that DBDOC was unable to build the graphics called for; either the build was incomplete or some of the graphics are trying to link to graphics that no longer exist

2.12.6 Function Code Descriptions and Uses: an index of all the function codes in your system

The Function Code Descriptions and Uses index is located in the Table of Contents. Click on **Function Codes** under **System Information**. There are three columns of links in this index.

1. Function code name, e.g. **ADAPT**: items in this column link to the documentation for the function code, including basic spec and output descriptions.
2. Function code number, e.g. **[FC24]**: items in this column connect to the corresponding entry in the numerical function code index. Usually you would come at them from the other direction, via the **Function Codes by Number** index in the main table of contents.
3. Function code uses, e.g. **USES(45)**: this item brings you to the function code uses index, an index of all the CADs or CLDs where that particular function code is used. Items in this index are linked to the function code hotspots on CAD sheets.

<	[FC11]	USES (1)	Low Select
>	[FC10]	USES (2)	High Select
A	[FC2]	USES (110)	Manual Set Constant
A-INT	[FC52]	USES (40)	Manual Set Integer
ADAPT	[FC24]	USES (45)	Adapt

The link FROM function code hotspots to CAD sheets back to the function code index is disabled by default. In the disabled state, clicking on the function code number will not take you to the function code uses index.

Function Code Hotspots can be turned on or off via the **Enable function code hotspots** checkbox on the **View** tab of the **Options** dialog (in the main browser menu). You can also turn on the option by left clicking on a function code hotspot position that will bring up the following dialog:

You can choose to:

- Enable the hotspots
- Disable the message box from appearing again the next time you click on a function code hotspot position
- Do nothing at all by clicking **OK** without checking either option or clicking the **Cancel** button

2.12.7 Function Block Index: a list of all the function blocks used on a CAD/CLD

The **Function Block Index** lists and links every function block on a document. You can display it by clicking on any function block on a CAD or CLD. If function block hotspots have been disabled, this index will not be shown. See Enabling function block hotspots for information on how to enable and disable function block hotspots.

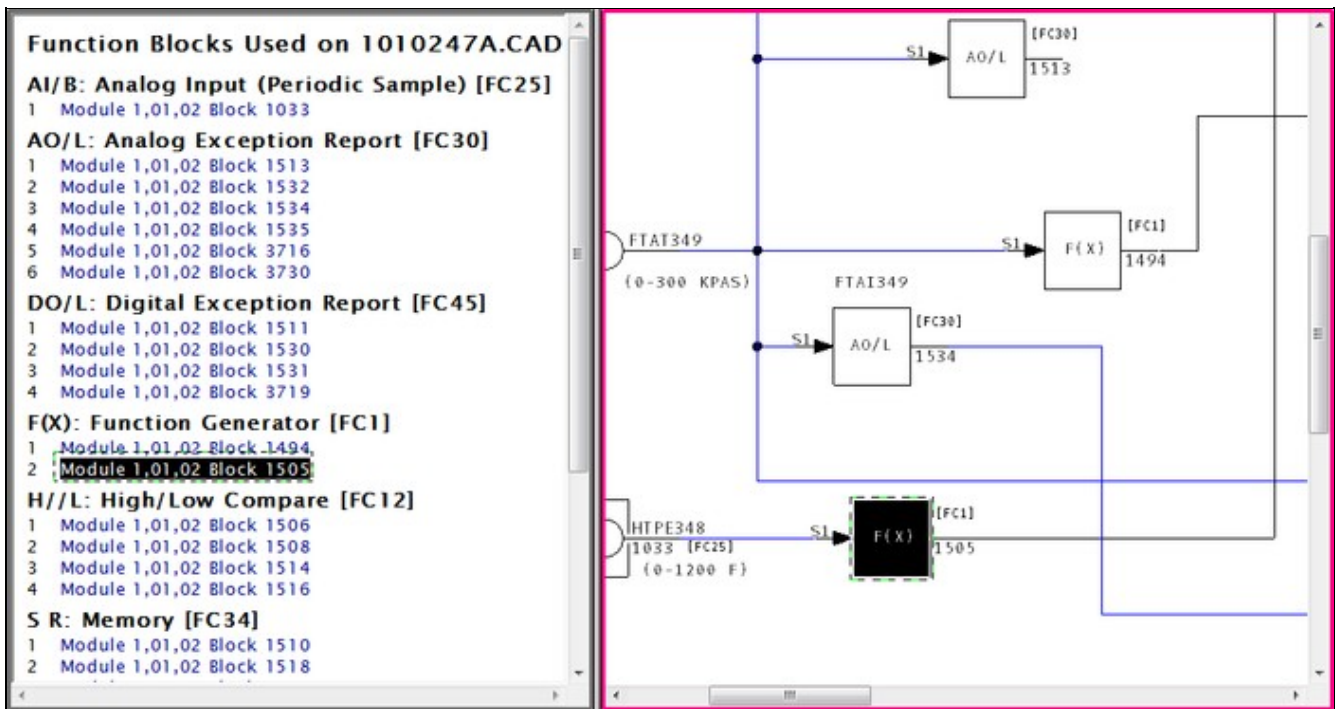

2.12.8 Graph of F(x) (Function Code 1)

INFI 90 Function Code 1 implements user-specified piece-wise linear functions. Hyperview displays a sketch of the function in the function box when specs are visible (hint: use the **S** key). Right-click on the block number and select **Show Live Function Graph for this Block** to get a larger, resizable, movable graph. Example of a Function Code 1 Graph:

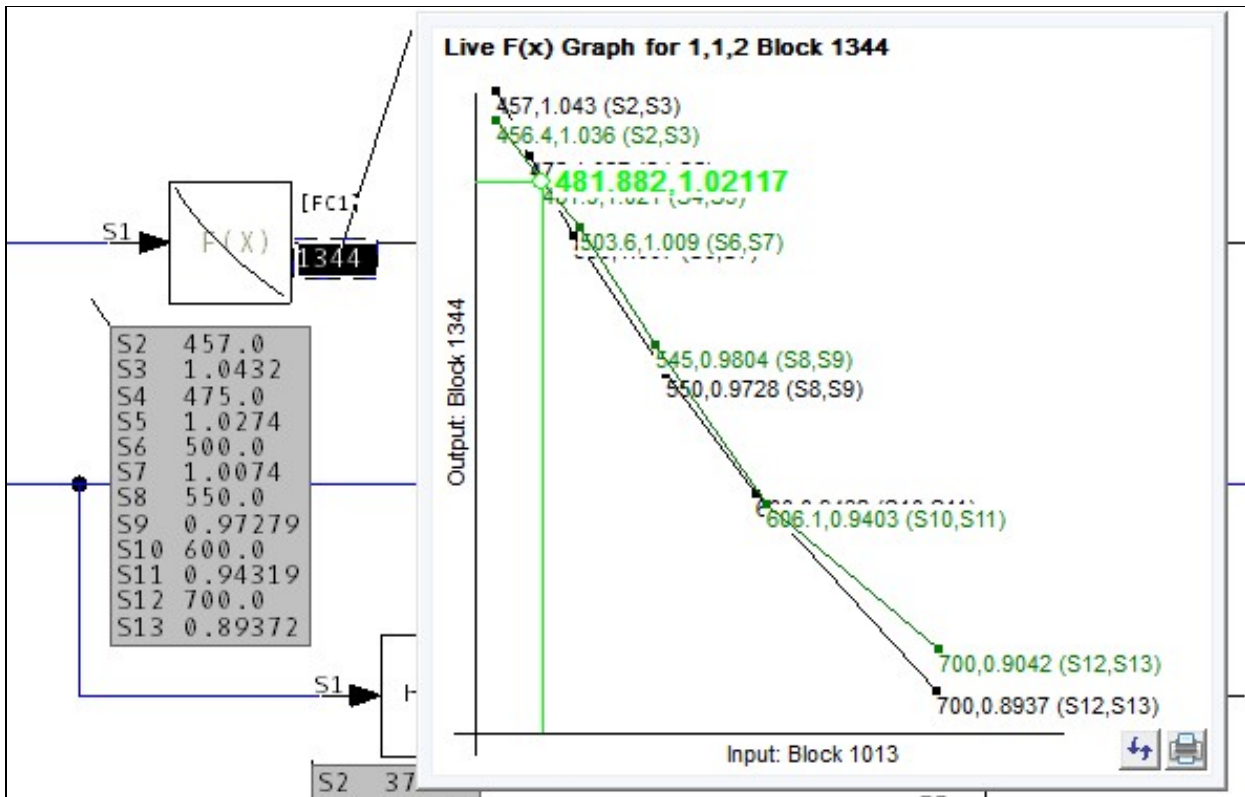

You can open all Function Code 1 graphs on a sheet by right-clicking anywhere and selecting **Live F(x) Graphs | Show All** from the popup menu. You can close them all by selecting **Close All** from the same menu. You can print any particular graph by clicking on the print button  in the lower right hand corner. The graph will be printed full-page size.

The graph plots the spec values that define an input-output function. In version 10.4 and newer, the input and output values are also plotted directly on the graph, and are updated at the same rate as the underlying document. You can force a data refresh by clicking the refresh button in the graph window.

2.12.9 Adapt Block

Follow the link for Function Code 24 from the FUNCTION CODE INDEX to all the instances of Adapt Blocks in your INFI 90 system. You can easily go from the Adapt Block to the block it adapts (or the other way around), even if they are on different pages. Live monitoring will show the adapted spec in grey on an adapt block. Adapted specs are further marked with a right angle bracket beside the spec (>).

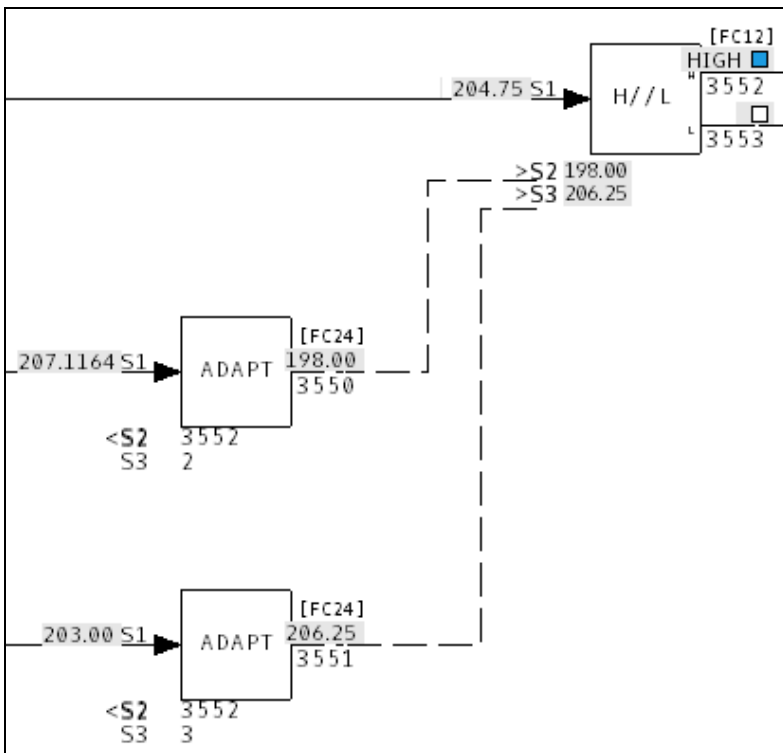

2.12.10 Rung Block Display

Rung blocks are heavily used in some systems: turbine control systems designed by ETSI, for example. When specs are visible, Hyperview displays a ladder diagram that describes the function of the rung block. Live monitoring will show which inputs are open and closed, plus the output.

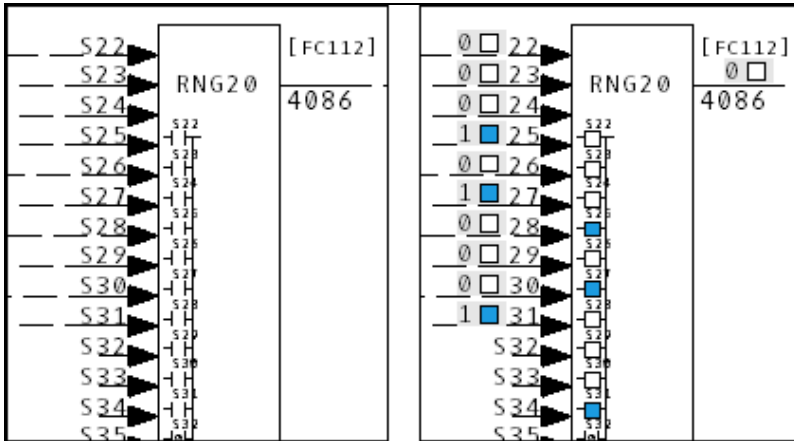

Forced outputs are shown in Version 9.60 and later.

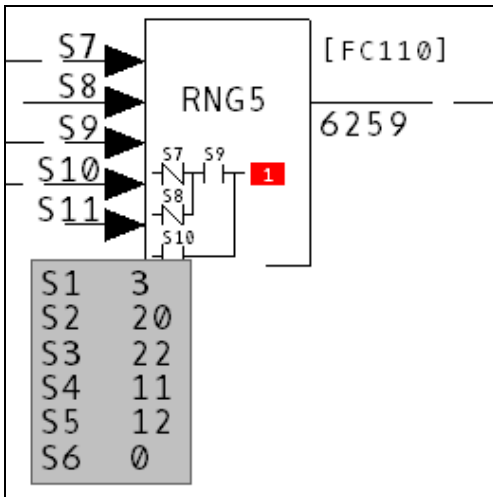

Hyperview will display 0, 1, H or ? in a red box after the output.

2.12.11 AutoCAD and MicroStation

AutoCAD and MicroStation drawings are useful to have in the DBDOC build. Viewing them in Hyperview is much easier than working with large stacks of sheets. Where the INFI 90 tag name is on the drawing or can be constructed from data in attributes, there will be a direct link to the tag in the CAD/CLD sheet and on graphics. Live information can be displayed on these drawings. Links are also constructed based on a partial text phrase match algorithm that can be activated in the BuildPlus Project Options. We can customize the way we identify tags so if you are not getting the links you want, please contact us.

2.13 Managing Live Loop Connections

2.13.1 About live data settings

Live data can be displayed on documents in Hyperview and plotted in the Watch Window. This data must be fetched from your system, generally from a CIU. A DBCOC data server called CIUMon talks to both Hyperview and the CIU, and transmits data requests and responses.

Different systems have different configurations for live data. Some have one CIU, and some many. Some have serial port modules available. Some have CIUMon servers running in relay mode located on an intermediate LAN to provide NERC compliant live data to the Business LAN.

Hyperview needs to know what data servers to talk to. Generally this is specified right in the project file (built by BuildPlus during the build process). The live data connections can also be specified from inside Hyperview.

Your live data settings have probably already been configured, built into the project file. If no settings are built into your project file, or you need to change or override the built in settings, you can create custom settings in the **Live Loop Settings** tab in the **Options** dialog.

2.13.2 About the Live Loop Setup dialog

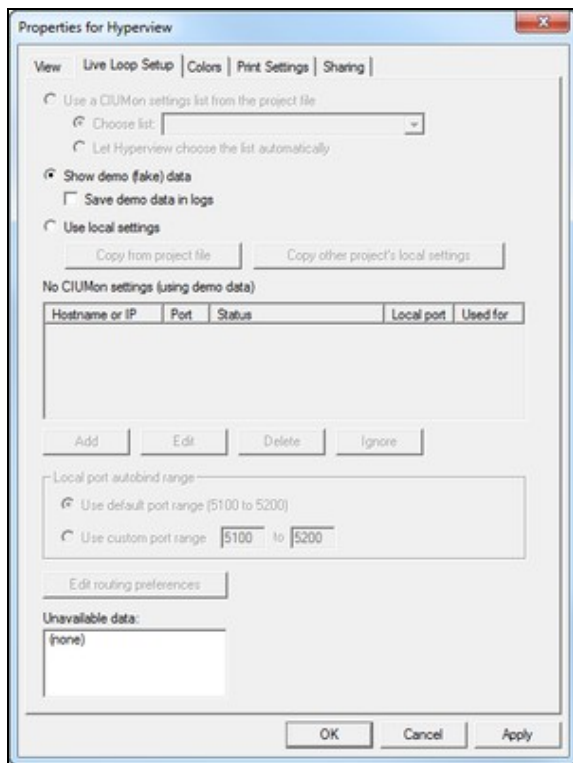

The **Live Loop Setup** dialog is the control center for managing and monitoring your live loop setup. This is where you can see what CIUMons Hyperview is connected to and whether there are any connection issues. Although the current version of Hyperview automatically routes data requests to be best placed CIUMon, it is also possible to force requests for particular loops or PCUs to be sent to a specified CIUMon. If a serial port module is available for a particular PCU it will be used automatically for requests for that PCU.

In general, your live loop configuration will be determined by your DBDOC administrator and built into your project file. If this configuration has not been defined in this way, or you wish to override it, you can create a custom live loop configuration in this dialog which can include CIUMons of your choice, or force certain CIUMons to be "ignored" by Hyperview.

 **Note:** You can see an icon representing the status of your live loop connections in the **Live Data Status Bar**.

2.13.3 Choosing a settings list

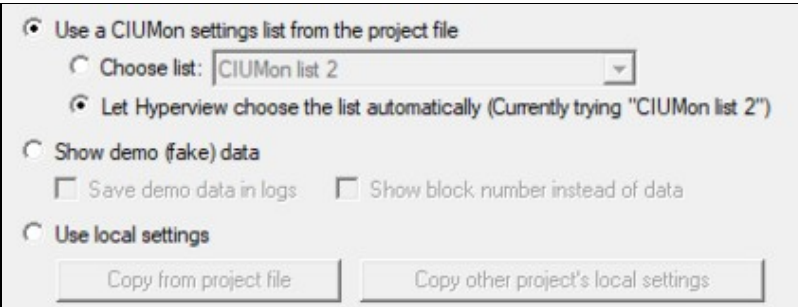

The screenshot shows a dialog box with the following options:

- Use a CIUMon settings list from the project file
 - Choose list:
 - Let Hyperview choose the list automatically (Currently trying "CIUMon list 2")
- Show demo (fake) data
 - Save demo data in logs
 - Show block number instead of data
- Use local settings

At the bottom, there are two buttons: "Copy from project file" and "Copy other project's local settings".

Live loop configuration is handled a bit differently from before starting with Hyperview 10.4. As before, settings can be built directly into the project file by your DBDOC administrator, but now it is possible to group the CIUMons into different lists based on what network context the CIUMon is located in. For example, many sites have one or more CIUMons running on their DCS LAN which are accessible to Hyperviews on the DCS LAN, but not accessible to Hyperviews on the business LAN. Those sites might add a second settings list that included a CIUMon running in relay mode on the business LAN.

You can choose among project (dbdoc file) settings, custom local settings, and demo data.

Use a CIUMon settings list from the project file

The settings lists built into the project file can be seen in the drop-down under **Use a CIUMon settings list from the project file**. Usually there will be only one list, but it is possible to build multiple lists into the project file. Your DBDOC administrator might do this in order to specify different CIUMons to be used in different network contexts. Hyperview will try to choose the correct list for you (based on which CIUMons it can connect to), but you can override this choice manually.

Show demo (fake) data

Use this option to test the visual display of live data when your Hyperview is not hooked up to a CIUMon. You would never use this option under normal circumstances.

Use custom settings

This choice allows you to define a local persistent CIUMon list. Use it if there are no settings built into the project file, or if you want to create different settings. Pressing **Reset to match project file** will re-initialize the custom settings to match the currently selected project file settings. If you want to create custom settings

that are similar to the project file settings, that's a good place to start.

2.13.4 Understanding your current live loop settings

The list of CIUMon servers that Hyperview is currently connected to (or trying to connect to) are displayed in **CIUMon Settings**. If you select a different server list as described above, a different set of servers will be displayed here. In general this list of servers will have been preconfigured at the build stage, and built into the project file. More than one list may have been built into the project file (typically to support fetching live data in different network contexts). In this case Hyperview will generally have selected the appropriate list automatically.

Each CIUMon server in the list is connected to either a CIU, a Serial Port Module, or another CIUMon server (in relay mode) which is ultimately connected to an actual CIU or SPM.

Unlike in previous versions of Hyperview, it is not necessary to specify in Hyperview which loop a CIUMon server is connected to. CIUMon reports its loop connection directly to Hyperview, and data requests are routed appropriately. The self-reported CIU location is shown in this dialog.

Location	Port	Status	Local port	Used for
asclepius	5099	Connected to loop 3	5100	6,197,1
archimedes	5099	Connection status unknown		
localhost	5098	Blocked	5101	

Location and Port

This is the computer and port that a CIUMon server is running on. Hyperview makes a connection to the CIUMon at that location. This is the only information about a CIUMon server that Hyperview needs to know.

Status

This column shows the current status of the CIUMon connection, whether it is connected, not connected, or blocked. If Hyperview is connected to a version 10.4 or later CIUMon, CIUMon will self-report which loop it is connected to, and that information is displayed here. Similarly, if the CIUMon is connected to an SPM to talk to a specific Loop and PCU, the PCU number will be shown here.

Note: If Hyperview is connecting to an older CIUMon (pre 10.4), that CIUMon will not self-report its CIU location. In that case, the CIU location information can be provided manually via **Routing Preferences** (see below). When CIUMon settings are converted to version 10.4, routing preferences are automatically created for unusual cases, and you can also create them manually if needed. This should rarely be necessary.

Local port

This column indicates which local port on the Hyperview computer is being used to make the connection with the CIUMon server. Normally it is chosen automatically from the default port range, but it can be specified

when a connection is defined, or a non-default port-range can be specified.

Used for

This column shows which loops are having their data fetched via that CIUMon. For example, if "3" is in this column, it means that data requests for Loop 3 are going to that particular CIUMon server.

2.13.5 Adding or modifying live loop connections

2.13.5.1 Adding a connection

To add a new live loop connection to a CIUMon server, press **Add** beneath the server list. The **Add CIUMon** dialog will appear. Specify the location of the CIUMon server Hyperview needs to connect to.

Note: You can only add, edit, and delete servers that are part of a **Custom settings** server list. You can't change a server list that is built into the project file.

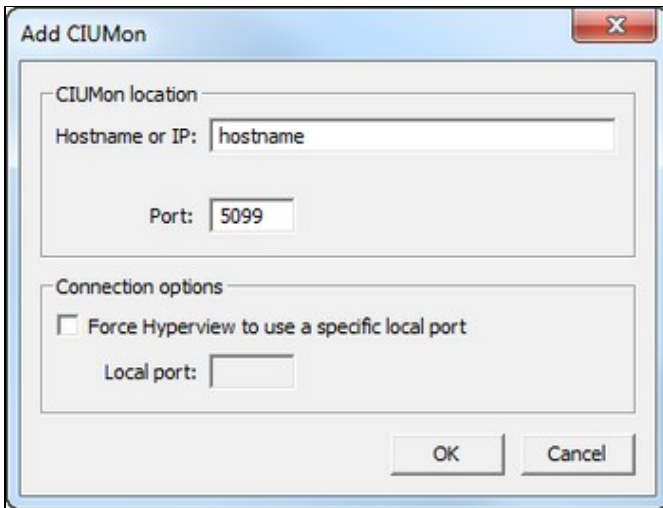

Hostname or IP

Specify the name (or IP number) the of the computer on which the CIUMon server you wish to connect to is running.

Note: To indicate that the desired CIUMon is running on the local machine, use **127.0.0.1**. Generally **localhost** will work as well, but this depends on your **hosts** file being configured correctly.

Port

Specify the port that the CIUMon server is listening on. By default this is 5099, but if a CIUMon server on your system has been configured to listen on a different port, you must specify that port here.

Force Hyperview to use a specific local port

Allows you to specify which port will be used locally for communications with the CIUMon server. It is usual to leave this blank, and allow it to be selected automatically from the default port range (or specified port range), but under some circumstances it may need to be set explicitly.

Local port

If you are forcing Hyperview to use a specific local port by checking **Force Hyperview to use a specific local port**, you must specify the port number here. You might do this if your Hyperview can only use one specific port through your firewall.

2.13.5.2 Editing a connection

To edit an existing live loop connection, select the connection in the **CIUMon settings** list and press **Edit**. The **Edit CIUMon** dialog will appear. Make the changes needed and press **OK**.

2.13.5.3 Deleting a connection

To delete an existing live loop connection, select the connection in the **CIUMon settings** list and press **Delete**.

2.13.5.4 Ignoring a connection

To "ignore" an existing live loop connection, select the connection in the **CIUMon settings** list and press **Ignore**. Functionally this is identical to deleting the connection. When routing data requests, Hyperview will act as though that connection did not exist. However, it is temporary, because an ignored connection can be **unignored** and reinstated. If for some reason you want to force Hyperview to never send requests to a particular server, you can "ignore" it.

2.13.6 Specifying a non-default local port range



Local port autobind range

Use default port range (5100 to 5200)

Use custom port range to

By default, Hyperview will assign a local port to a CIUMon connect automatically, choosing an available port from within the default port range. Unless you require specific port behavior, for example due to firewall constraints, it is best to stick with this default.

To specify a custom local port range, check **Use custom port range** and then specify the range.

Note: You can only specify a custom port range for a **Custom settings** server list.

2.13.7 Adding routing preferences

Normally data requests are routing to appropriate servers automatically.

In the event that you want to specify that requests for a particular loop or loop-pcu combination should be routed to a particular server, click on **Routing preferences**.

Note: If Hyperview is connected to a pre-10.4 CIUMon, the CIUMon will not self-report the location of the CIU it is connected to. Use a routing preference to specify this location if needed. The CIUMon will otherwise be assume to be connected to a CIU on Loop 1.

To add a routing preference, click on **Routing preferences** to bring up the **Add preferences** dialog.

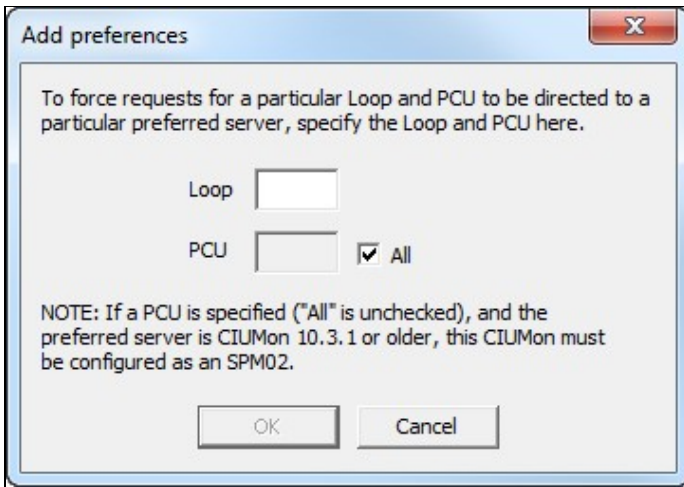

Specify the loop (and PCU, if applicable) you wish to make a routing preference for.

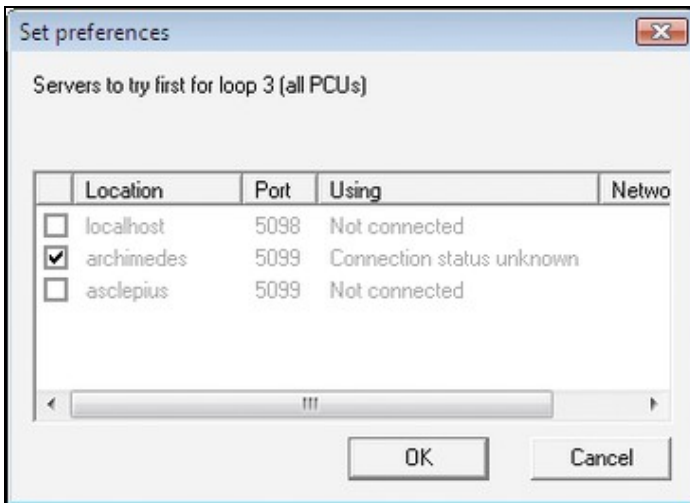

Choose the CIUMon server to which data requests for that loop-PCU should be routed.

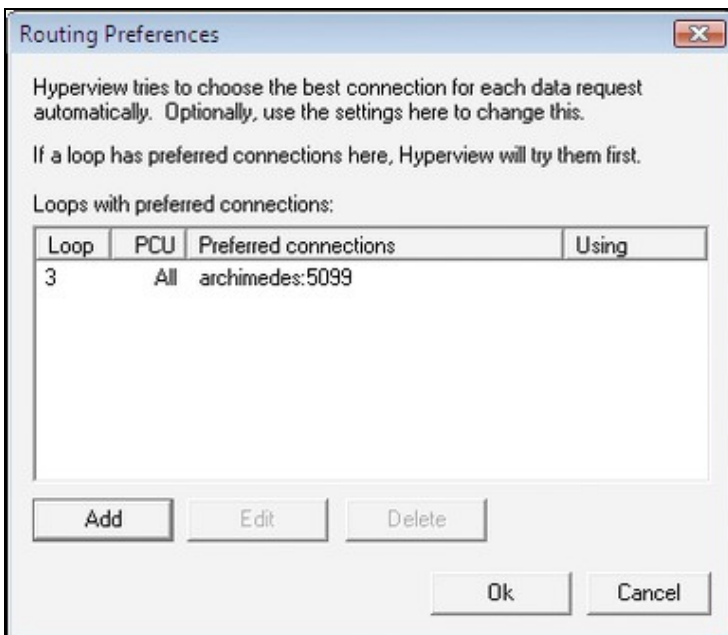

You can also edit and delete existing routing preferences.



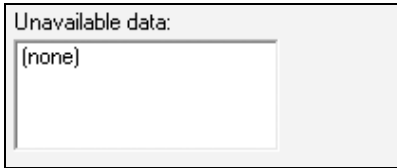



2.13.8 Unavailable data



If data cannot be fetched for a particular loop or PCU, the loop and PCU are displayed here. If live data monitoring is turned on, but there is no CIUMon connection established, there will be items in this box. This could also happen if the only CIUMon available is connected to a serial port module on a certain PCU, and data is being requested for a different PCU.

2.13.9 Status of live data connections

It's easy to see the current status of your live data connections. Just look at the network icon in the Hyperview status bar.

Connection OK (Project Settings)		CIUMon is connected using project file live data settings, communications are happening, user is not blocked
Connection OK (Custom Settings)		CIUMon is connected using local custom settings, communications are happening, user is not blocked
Unable to connect		Cannot communicate with specified connections
No connection specified		No connections have been specified in the Live Loop Setup options dialog
Connection blocked		User is not allowed to collect data on any of the specified connections -- they have been blocked by the DBDOC administrator
Demo settings		Demo data is being displayed, not data from CIUMon

2.13.10 Compression of Hyperview data requests

- Hyperview examines basic Loop, PCU, Module, Block (LPMB) information and combines requests before sending it out to CIUMON.
- If two people are using Hyperview to monitor the same set of points, will CIUMon will only pass on one set of requests to the CIU.

2.14 Managing Live Data Load

2.14.1 Overview of live data bandwidth limitations when fetching live system data

Until recently, the live data fetch rate available in most systems was very low, about 10-20 values per second. DBDOC, along with other system applications, was subject to this very low data bandwidth.

DBDOC 10.4, when used with the RoviSys Turbo, changes this picture. When used in conjunction with the RoviSys Turbo, DBDOC achieves peak data fetch rates of over 100 values per second, and routine data rates of more than 30 values per second when fetching data continuously.

Before DBDOC 10.4, a DBDOC installation might have used a RoviSys Turbo to interface with a Composer CIU, or to multiplex a CIUMon server with the CIU connection of an existing EWS. With DBDOC 10.4 the RoviSys Turbo can still be used for these purposes, but it can also be used with all CIUs (including older ICI01 CIUs) to increase data fetch rates by a factor of five or ten.

Despite this groundbreaking improvement in live data availability, bandwidth is relatively speaking, low. You need to be aware of the very limited live data fetch rate available in most systems, and techniques to avoid overwhelming the limited capability as you use live data display and trending features in Hyperview. When multiple users of Hyperview all fetch live data from the same CIU, they share the bandwidth available, so if that is the case in your system, you need to be doubly aware.

The good news is that the extra bandwidth provided by DBDOC 10.4 and RoviSys Turbo make it much easier to use DBDOC's Watch Window for data trending without overwhelming capabilities of your system.

Read on for critical information about the following:

- How to tell how much data is being fetched by your Hyperview browser.
- How to manage the Watch Window data load in Hyperview.
- How to manage the data load of live data display in Hyperview.

2.14.1.1 Constraints on live data fetch rate

Fast facts:

- A single CIU without RoviSys Turbo gives fewer than 20 values per second to the entire world of DBDOC.
- Multiple CIUs without RoviSys Turbo can give fewer than 20 values per second each.
- A serial port module can give DBDOC as many as 80 values per second from the PCU it is serving, a capability that very few are using.
- The updated RoviSys Turbo uses an optimized fetching and polling strategy, and has been clocked at over 100 values per second in the field, and routine data rates of over 30 values per second. This is a vast improvement, but still quite constrained.

Ways to increase the bandwidth available:

- Use the RoviSys Turbo in conjunction with DBDOC 10.4 in order to increase your data fetch rate by a factor of five or ten.
- Multiple CIUMon processes multiplexed to each of your EWS CIUs will give you more data. Use RoviSys Turbos to multiplex CIUMons to EWS CIUs.

- If you have a small number of PCUs, multiple serial port modules will give you a great deal more data.

CIU setups and how they affect available bandwidth:

- **Single CIU** – A single CIU should probably be on Ring 1, unless it cannot be, or unless the main system is not on Loop 1. Be aware of the extra load of bridging from one loop to another, which has to be done by way of Ring / Loop 1. If you have only one CIU available for DBDOC, you are limited to the base 10-20 values per second, unless you also use the RoviSys Turbo to optimize data fetching. Using this extra software will increase your data rate to 30-100 values per second.
- **Multiple CIUs** – You may have more than one EWS, and each might be on a different Loop. It is easy to take advantage of DBDOC CIUMon and RoviSys Turbo. We encourage you to multiplex any EWS CIUs you have. For 10% to 20% of the cost of a CIU, you can have its spare bandwidth available for DBDOC. It is simple to implement and easy to reverse or suspend.
- **Serial Port Modules** – The Serial Port Modules are of immense value when used with DBDOC. Each is capable of giving up to 80 values per second from the modules in a PCU. Of course, you have to be satisfied that this does not load the PCU too much, but being on top of that is a manageable problem. As all the data from any PCU with its own Serial Port Module is offloaded from your CIUs, the system directly gains throughput, too.

2.14.2 Managing live data load

2.14.2.1 Managing data load for live data on documents

Tips for minimizing your bandwidth needs:

- **Slow mode**  should be used (not **Continuous mode** ) unless continuous data is necessary.

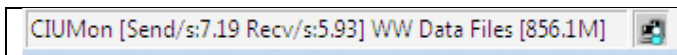

- Be aware of the **Send/s** and **Recv/s** fields in the **Live Data Status Bar** at the bottom of the Hyperview browser. These indicate how many data requests Hyperview is making per second, and how many data updates it is receiving.
- Be aware that unlike live data on documents, the Watch Window collects data even if it is closed or hidden.

If you use **Continuous mode live data display on documents**:

- On documents, live data is fetched for all visible points. If you are zoomed out on a graphic, and monitoring in **Continuous** mode, this can place a heavy load on the system. **Zoom in** on graphics.
- Better yet, avoid **Continuous** mode live data on graphics – save it for CAD/CLD diagrams!
- Make sure the default update interval for live loop annotations is no smaller than it needs to be. The default update interval can be specified in the **Options** menu on the Hyperview browser.
- Be aware that your data collection activities affect the bandwidth available to other Hyperview users sharing the same CIU connection.

2.14.2.2 Managing live data load for blocks in the Watch Window

The Watch Window is easy to use, and easy to abuse. Be aware of how much data you are asking for, and be especially careful when the Watch Window is closed. Closing Hyperview stops data collection in the Watch Window but when Hyperview is reopened it starts data collection again without necessarily opening

the Watch Window.

Tips for minimizing your bandwidth needs for live data collected by the Watch Window:

- Don't collect data you don't need. **Pause data collection** by clicking on the green clock  for blocks you are not actively trending.

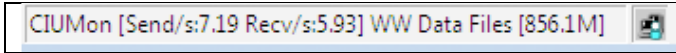

- Be aware of the **Send/s** and **Recv/s** fields in the **Live Data Status Bar** at the bottom of the Hyperview browser. These indicate how many data requests Hyperview is making per second, and how many data updates it is receiving.
- Be aware that the Watch Window will collect data even if it is not open.

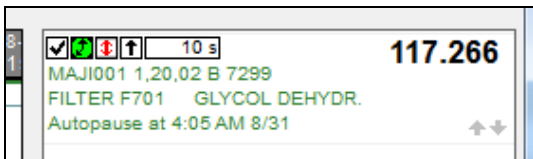

- The default update interval for Watch Window blocks is 10 seconds. **Increase the update interval** if you don't need that level of detail in your data. You can change the update interval by editing this field in the block list to the right of the plots: .

2.14.3 How to tell how much data is being requested (Live Data Status Bar)

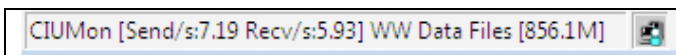

In Hyperview you are now able to tell how much live data a particular Hyperview is requesting per second. This information in the lower right-hand corner of the Hyperview browser is visible at all times in the status bar at the bottom of the Browser, and shows you exactly what data fetch load you are placing on the system.

The **Send/s** field shows how many requests Hyperview is making per second, from all sources (Watch Window, Live Loop Annotations, and live data directly on documents), while the **Recv/s** field shows how much data is actually being received from the CIU or serial port module. If the send rate is approaching the system data rate constraint (10-20 values per second per CIU), you need to take steps to reduce the data load in order to avoid performance degradation.

Keep in mind that the load from all Hyperview users has to be added together to really know what you can get from your CIU or CIUs.

For a global picture of data load, including requests from all Hyperviews and any other applications requesting data from CIUMon, you can view the CIUMon statistics. Using CIUMon options, or using CIUMonController.exe for CIUMon installed as a service, you can turn on statistics showing who is asking for data, and how much data they are trying to get. This can help a lot in sorting out the load on the system.

2.15 Hyperview Keyboard Shortcuts

Display	Topic display		Pane display	
	A	Toggle attributes/tag names	J	Move window divider
	S	Toggle specs	F	Toggle full screen mode
	V	Toggle Vegas Lights	Document rotation (PDF, AutoCAD, MicroStation)	
	Ctrl+E	Toggle error markers	R	Rotate counterclockwise
	Ctrl+Tab	Highlight hotspots	Shift+R	Rotate clockwise
	F5	Refresh		
	Esc	Abort <i>Draw</i> Operation		

Navigation	Changing location		Zoom	
	Backspace	Back	+	Zoom in
	Shift+Backspace	Forward	-	Zoom out
	Alt+Home	Home	Z	Toggle zoom
	B	Next topic in group	Table of contents	
	Shift+B	Previous topic in group	Y	Synch table of contents
	L	Next index entry	T	Top level table of contents
	Shift+L	Previous index entry	Ctrl+T	Toggle Treeview mode table of contents
	N	Next topic with search hits	Projects and windows	
	Shift+N	Previous topic with search hits	Ctrl+O	Open Project File
	H	Next search result in topic	Ctrl+N	New window
	Shift+H	Previous search result in topic		
	Ctrl+G	Find coordinates		
		Focus		
	F6	Move focus to next pane/window		

Tools	Tool windows		Search	
	W	Watch Window	Ctrl+F	Full text search
	E	Error Browser	Alt+D	Database search
	X	Cross Reference Window	Alt+T	Document title search
	F1	Help	Printing	
	On-document live data		Ctrl+P	Print
	M	Turn on or refresh snapshot data	P	Print with last settings
	Shift+M	Turn off snapshot data	The clipboard	
	Double M	Turn off snapshot data	Ctrl+A	Select all
	Bookmarks		Ctrl+C	Copy
Ctrl+D	Define bookmark	Ctrl+V	Paste	

